

# Wiringkit

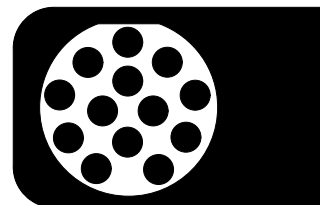

- D Einbauanleitung
- GB Installation instructions
- F Consignes de montage
- NL Montagehandleiding
- DK Montagevejledning
- N Monteringsinstruksjon
- S Installationsanvisning
- FIN Asennusohje
- I Istruzioni per il montaggio
- E Instrucciones de montaje
- P Instruções de montagem
- GR Οδηγίες εγκατάστασης
- CZ Návod k montáži
- SLO Navodilo za vgradnjo
- SK Montážny návod
- PL Instrukcja montażu
- TR Montaj talimatı
- H Beépítési útmutató
- HR Upute o ugradnji
- BUL Инструкция за монтаж
- RO Instrucțiuni de montaj
- RU Инструкция по монтажу и установке
- LT Montavimo informacija
- LV Iemontēšanas pamācība
- EST Paigaldusjuhend

**748164**  
SKODA

• Yeti

09/09 >>10/17

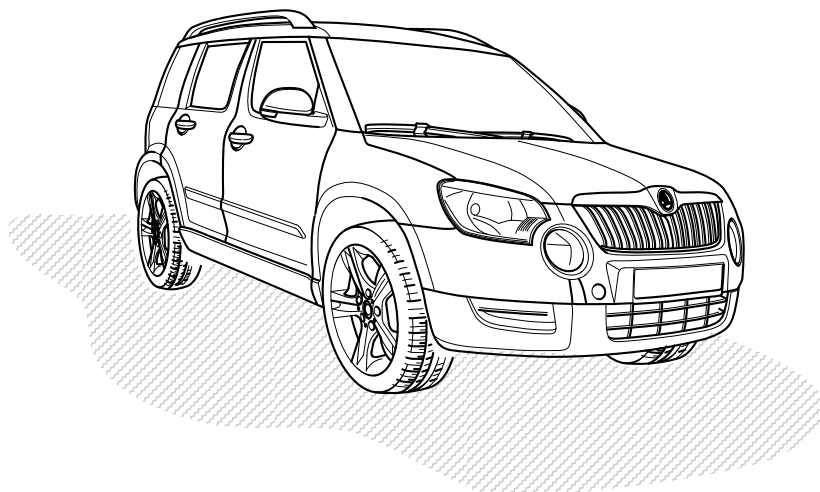

# OVERVIEW

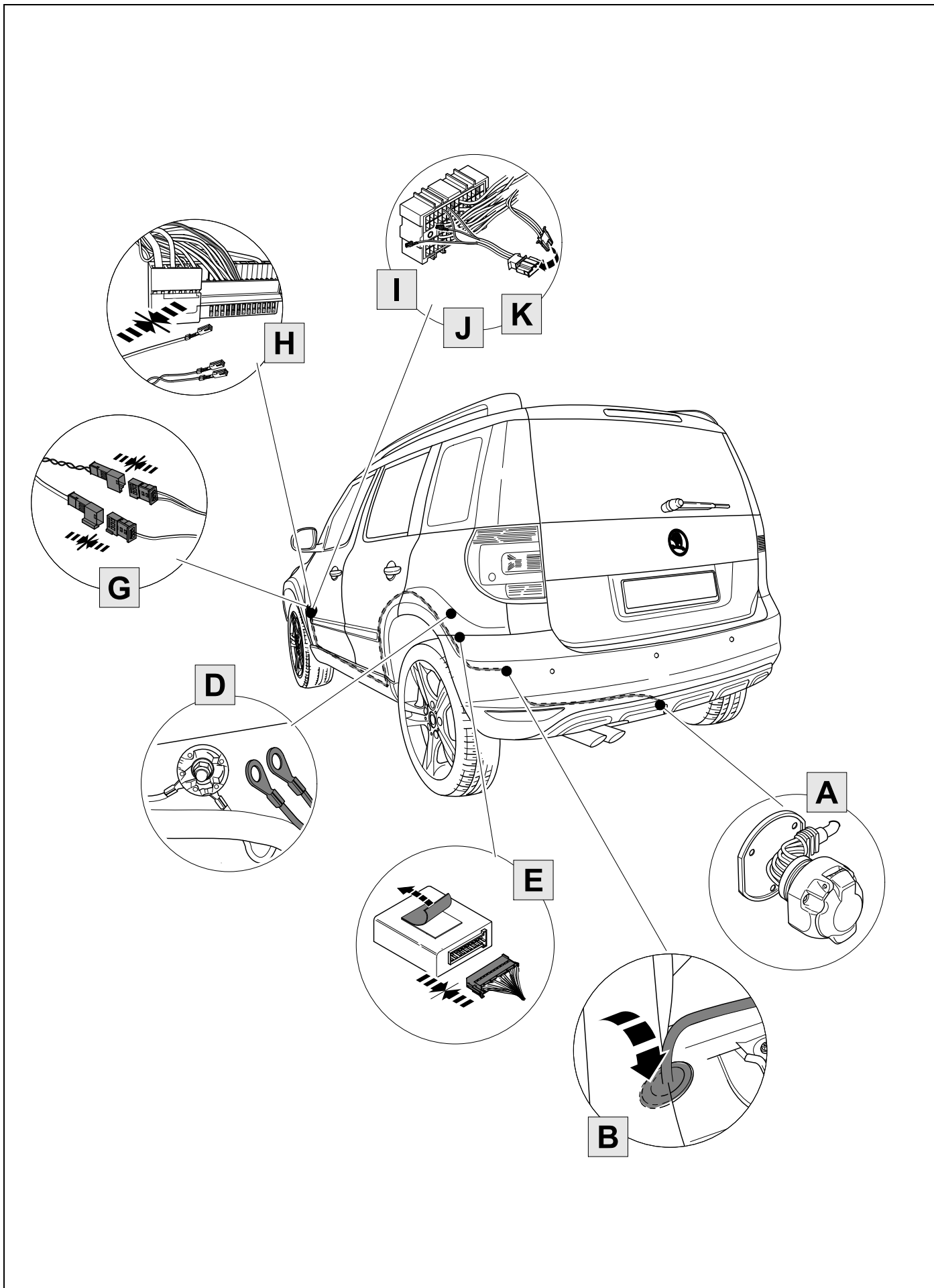

# KIT

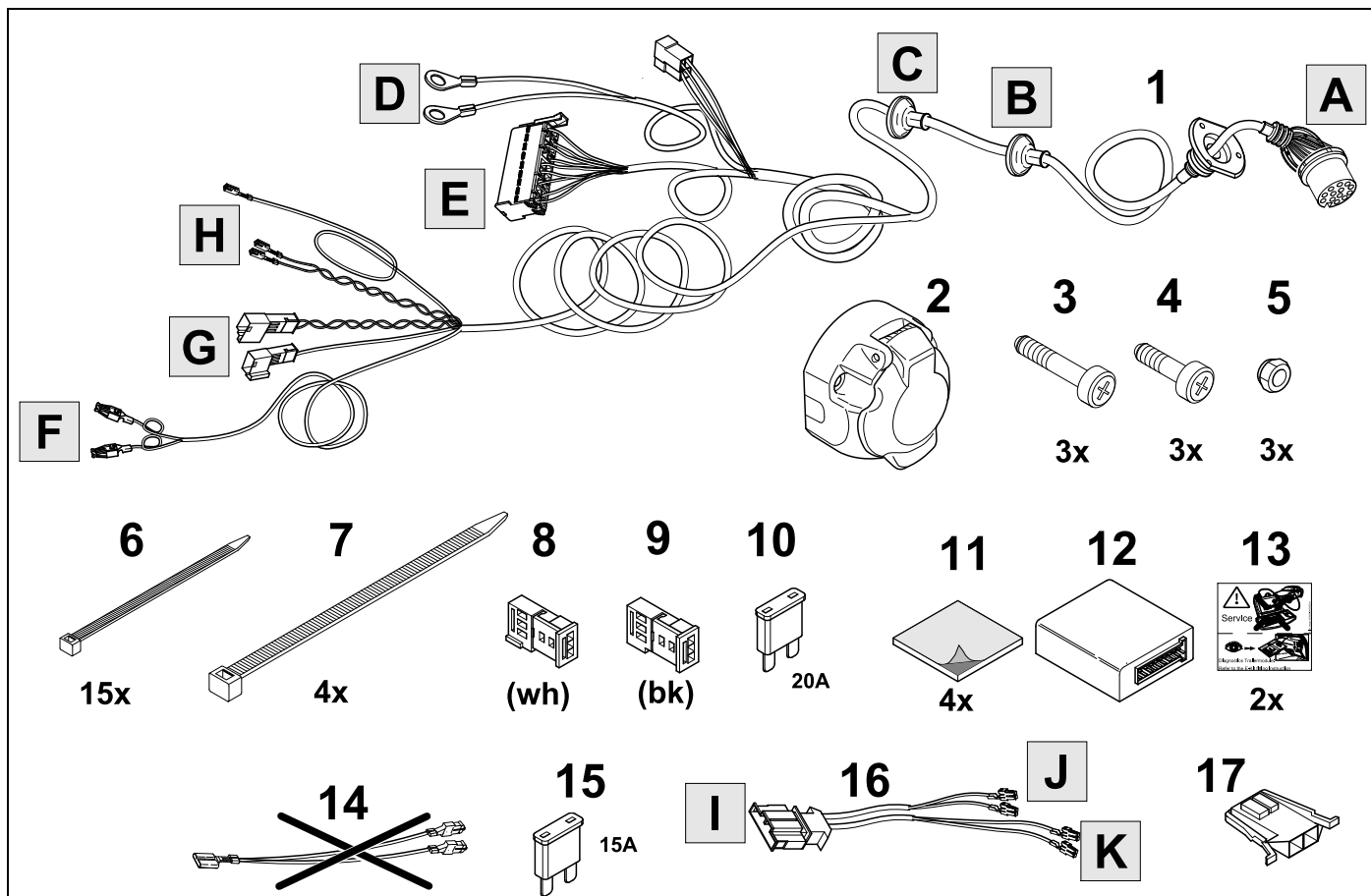

# TOOLS

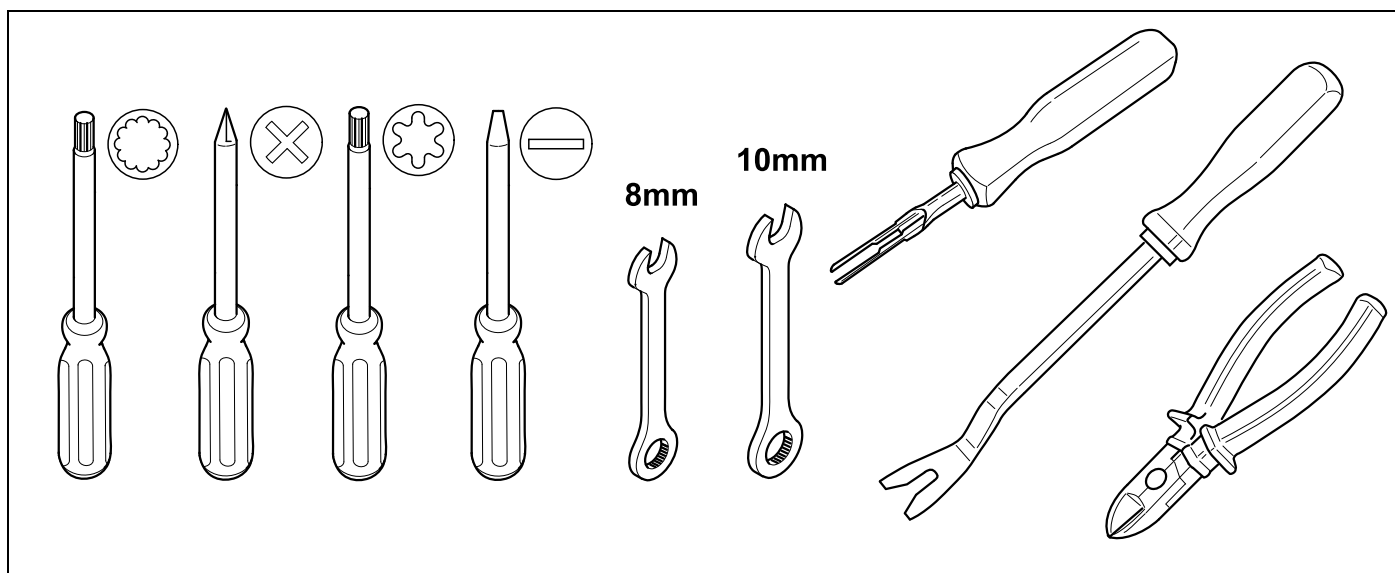

1

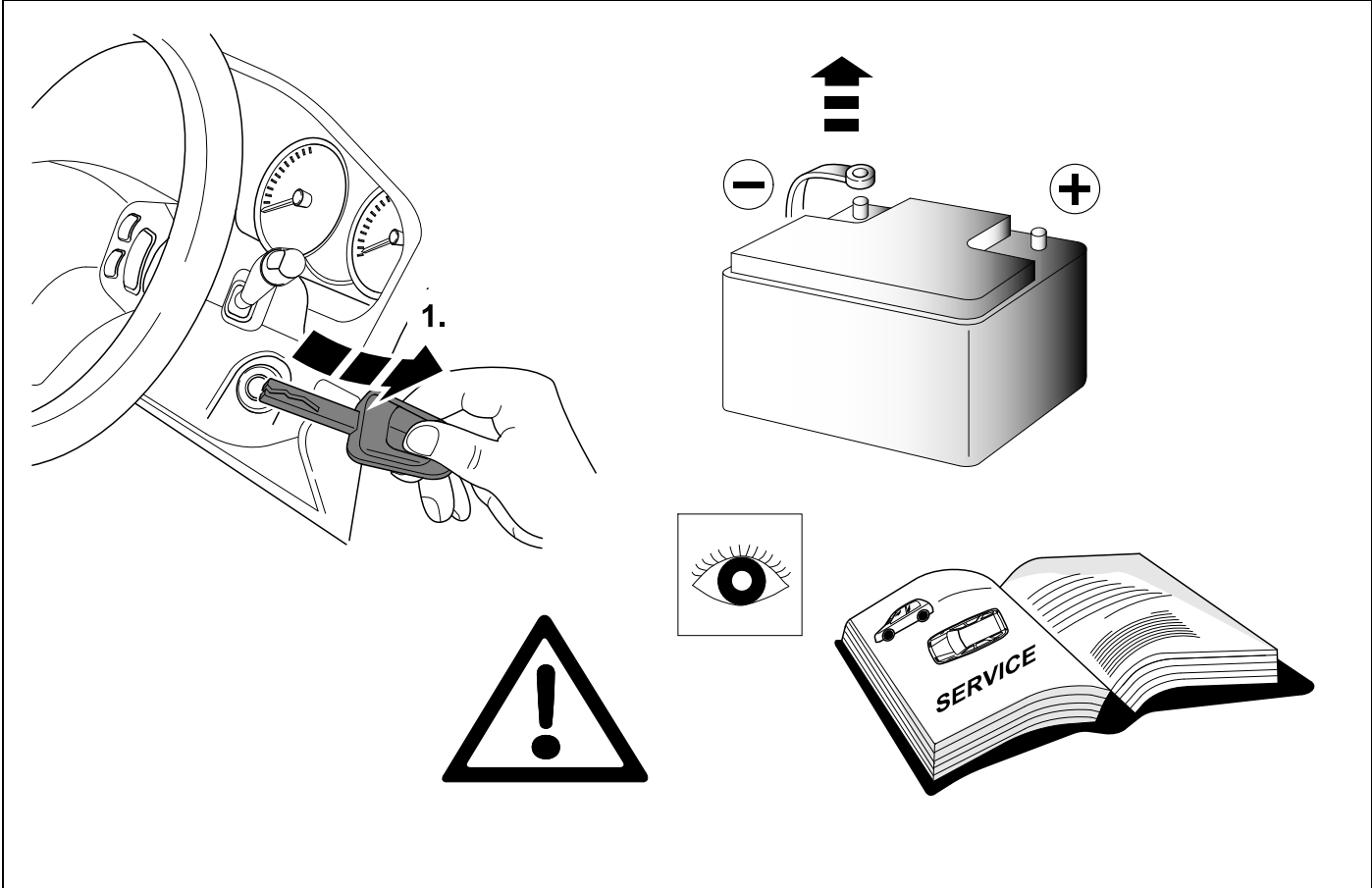

2



# 3 REMOVE

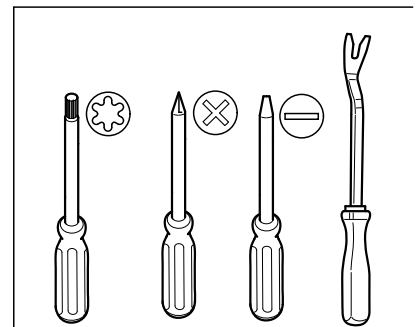
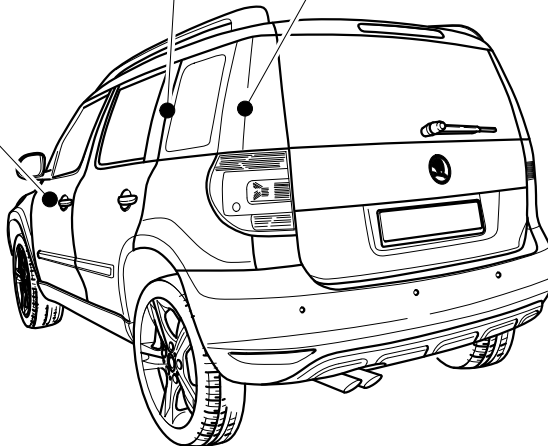
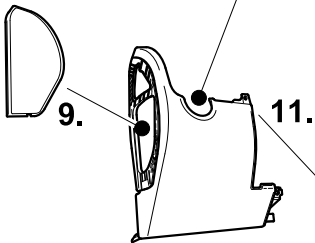
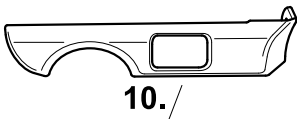
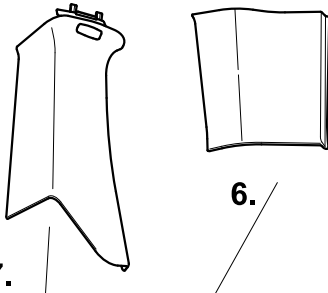
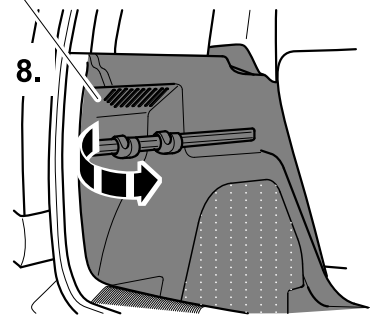
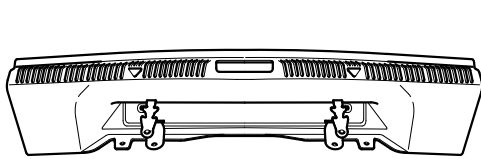
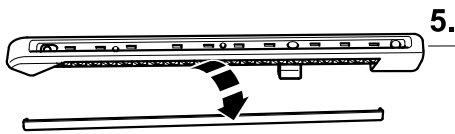
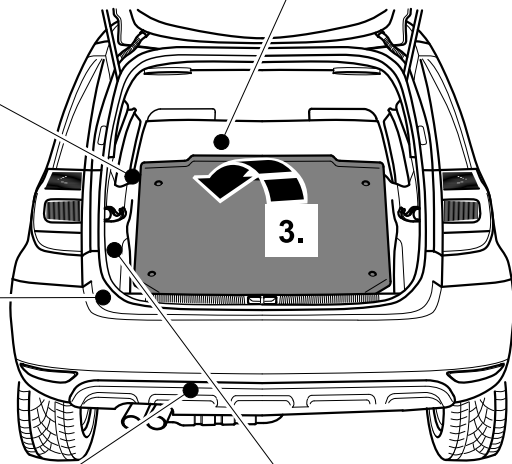
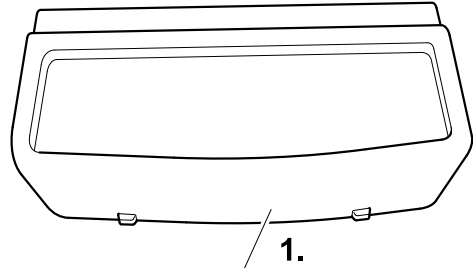
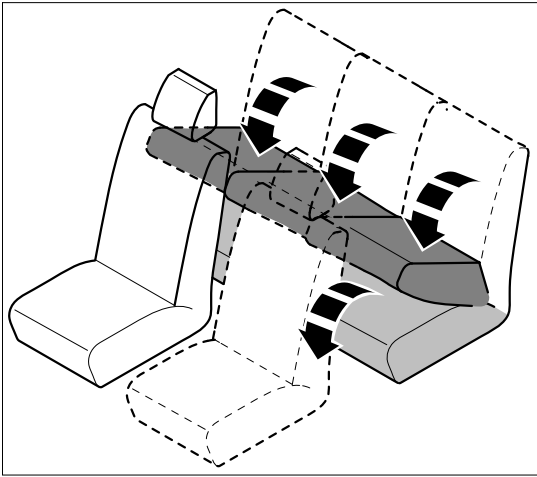

4

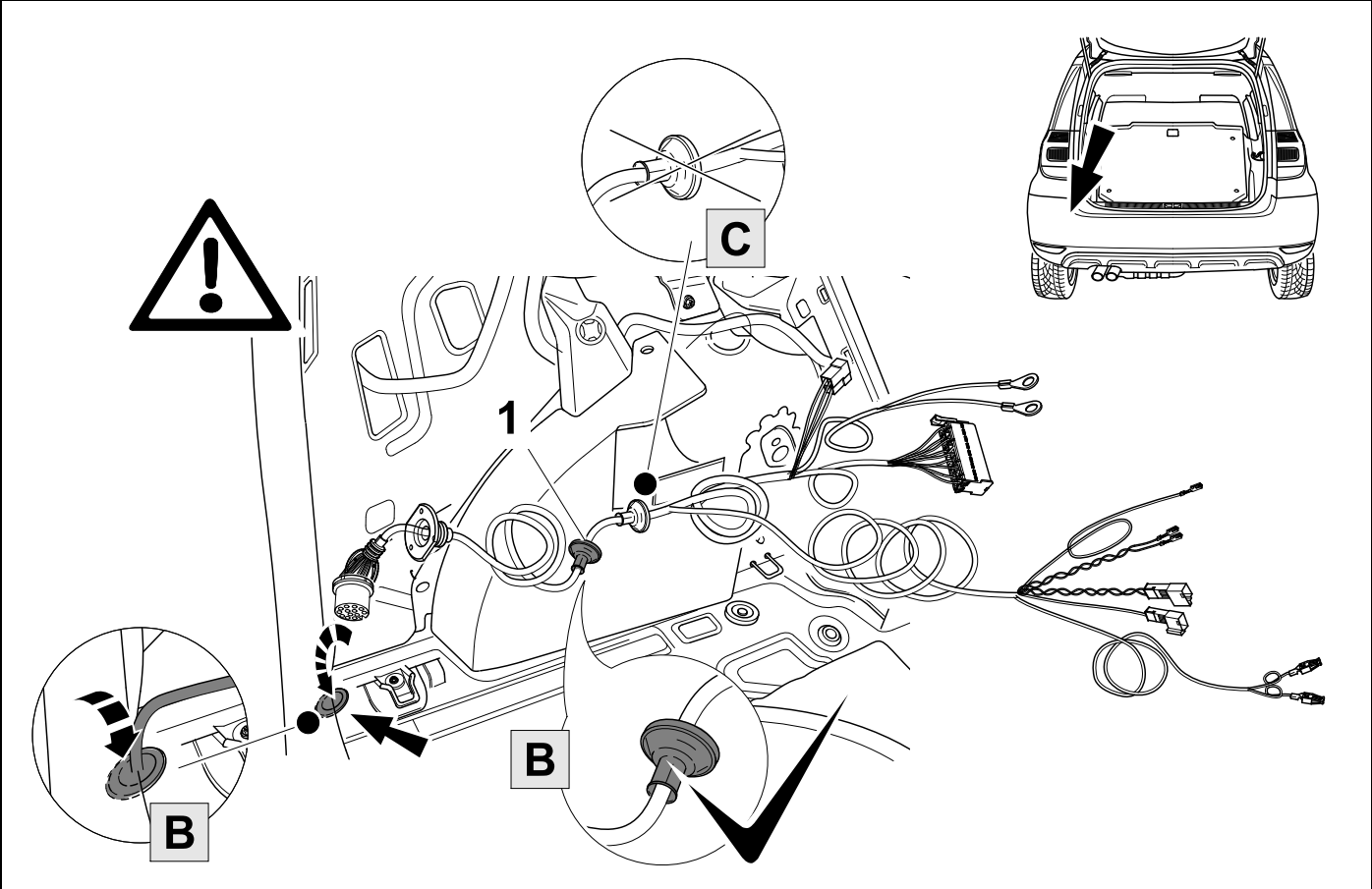

5

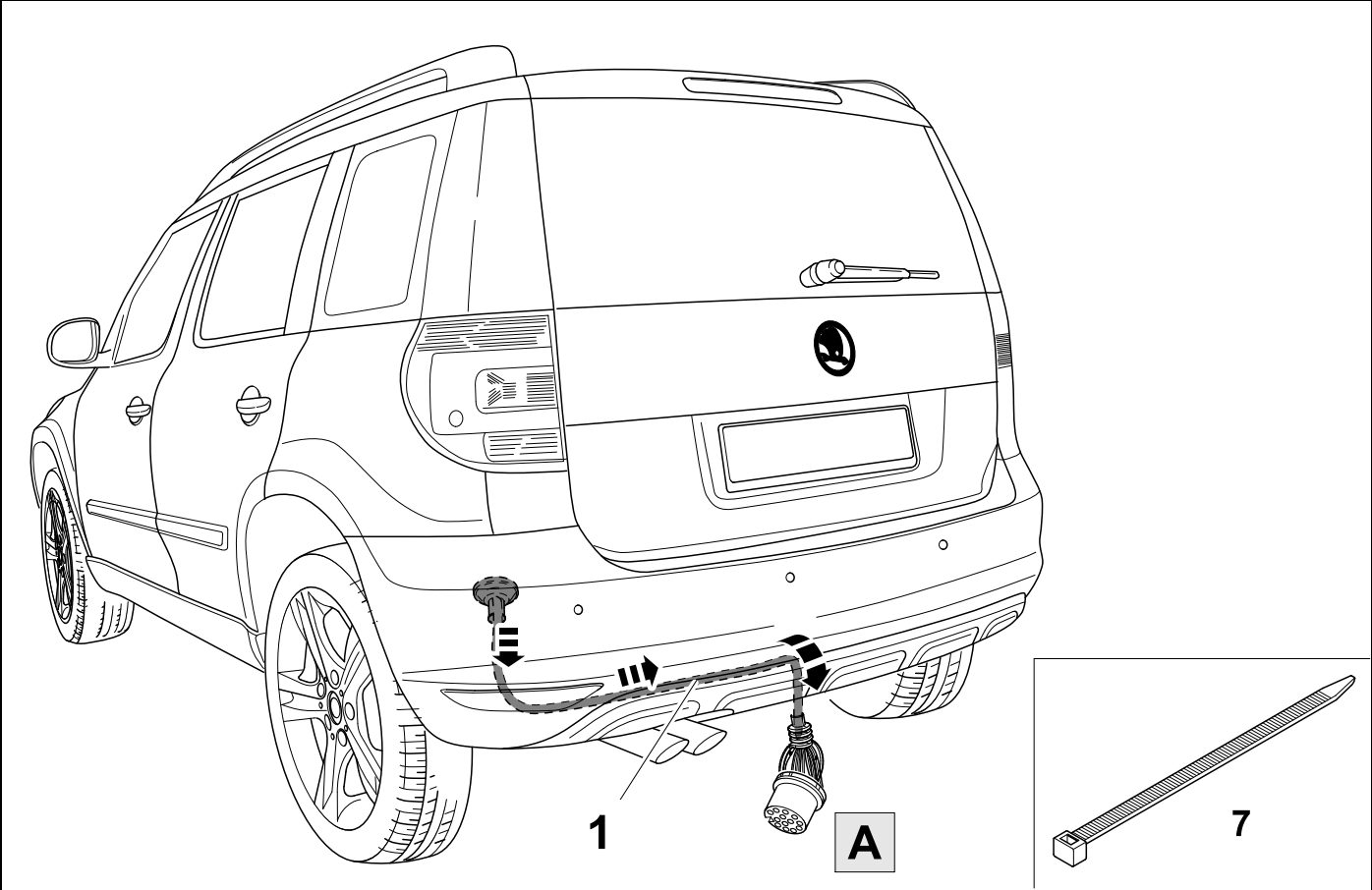

**6 OPTION 1**   $\Rightarrow$  **8**

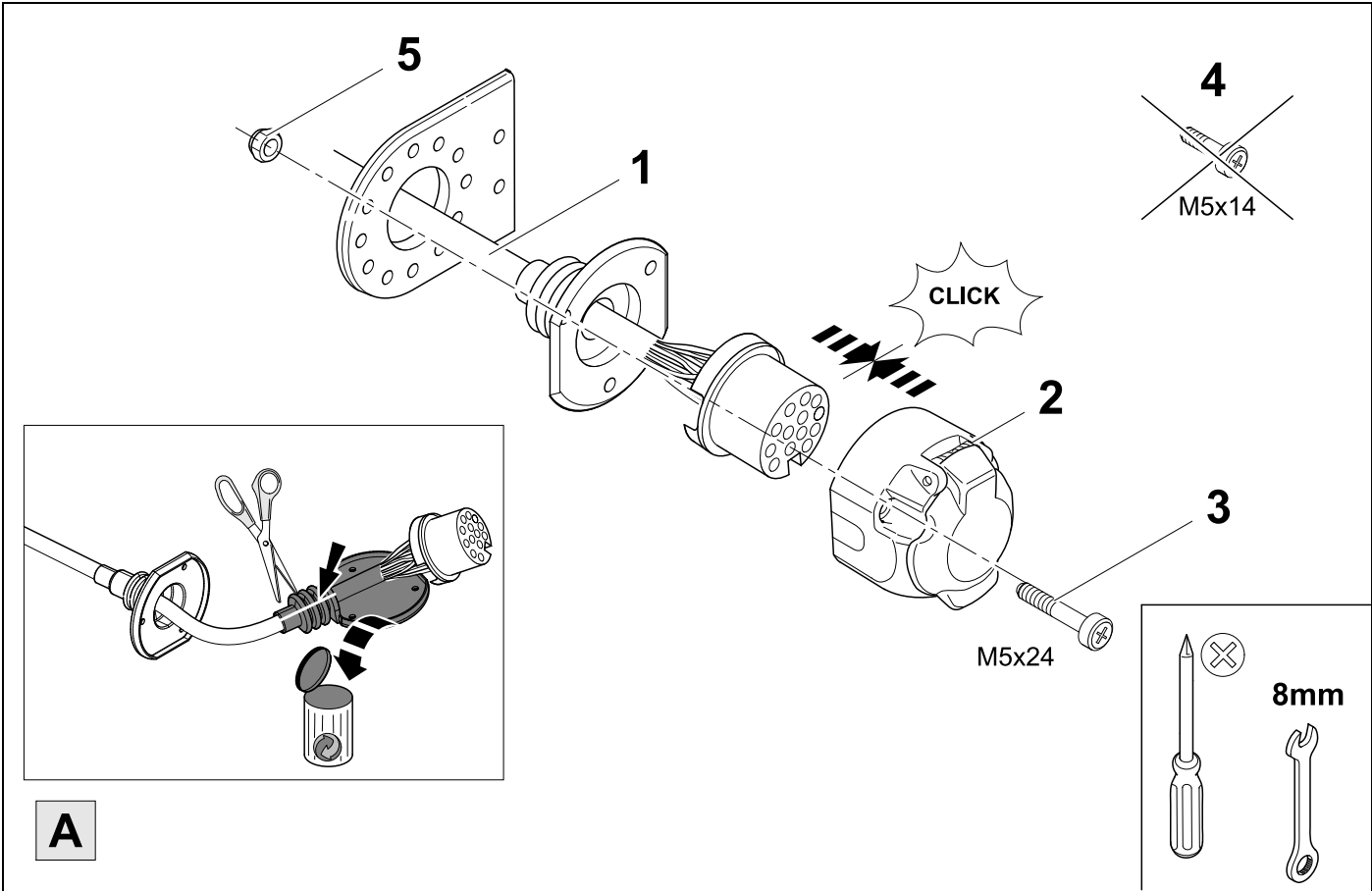

**7 OPTION 2**   $\Rightarrow$  **8**

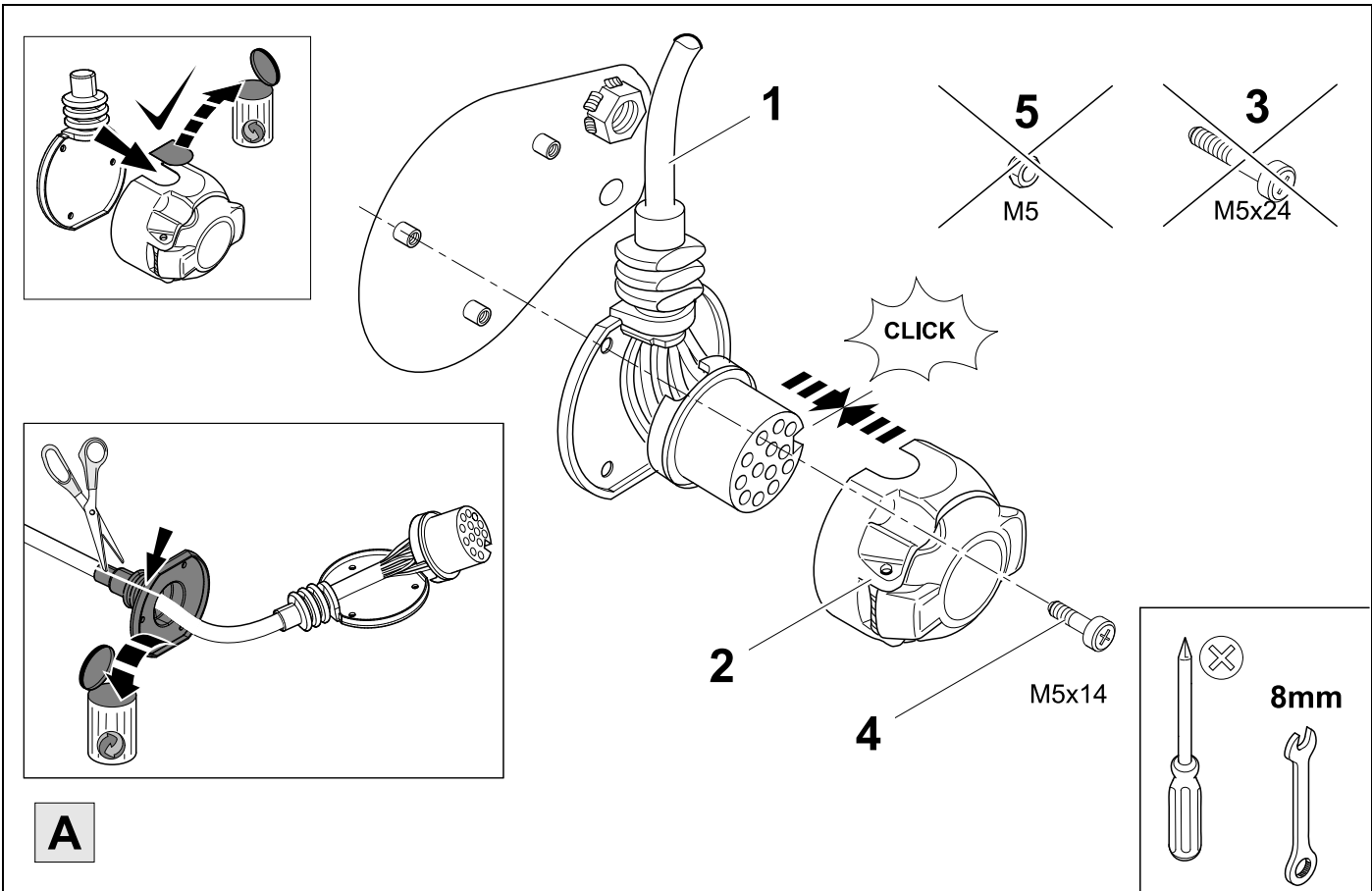



7- + 13-pin			13-pin		
1	bk/wh		8	bu/rd	
2	gy		9	rd/bu	
3	bn		10	ye	
4	bk/gn		11	bn/gn	
5	gy/rd		12	no	
6	bk/rd		13	bn	
7	gy/bk				

9	bk	wh	gy	gn	rd	bu	ye	bn	pu	or	no
(D)	schwarz	weiss	grau	grün	rot	blau	gelb	braun	violett	orange	nicht belegt
(GB)	black	white	grey	green	red	blue	yellow	brown	purple	orange	not occupied
(F)	noir	blanc	gris	vert	rouge	bleu	jaune	brun	violet	orange	inutilisé
(NL)	zwart	wit	grijs	groen	rood	blauw	geel	bruin	violet	oranje	niet aangesloten
(DK)	sort	hvid	grå	grøn	rød	blå	gul	brun	violet	orange	ikke anvendt
(N)	svart	hvit	grå	grønn	rød	blå	gul	brun	fiolett	oransje	ikke i bruk
(S)	svart	vit	grå	grön	röd	blå	gul	brun	violett	orange	ej använd
(FIN)	musta	valkoinen	harmaa	vihreä	punainen	sininen	keltainen	ruskea	violetti	oranssi	ei varattu
(I)	nero	bianco	grigio	verde	rosso	blu	giallo	marrone	viola	arancione	libero
(E)	negro	blanco	gris	verde	rojo	azul	amarillo	marrón	violeta	anaranja-do	no ocupado
(P)	preto	branco	cinzento	verde	vermelho	azul	amarelo	castanho	violeta	laranja	não ocupado
(GR)	μαύρος	λευκός	Γκρι	πράσινος	κόκκινος	μπλε	κίτρινος	καφέ	Μωβ	πορτοκαλί	δεν είναι κατ'επιτημένως
(PL)	czarny	biały	szary	zielony	czerwony	niebiesko	żółty	brazowy	fioletowy	pomarańczowy	wolny
(CZ)	černý	bílý	šedý	zelený	červený	modrý	žlutý	hnědý	fialový	oranžový	neobsazen
(TR)	siyah	beyaz	gri	yeşil	kırmızı	mavi	sarı	kahverengi	mor	portakal rengi	boş
(H)	fekete	fehér	szürke	zöld	piros	kék	sárga	barna	ibolyakék	narancssárga	nem foglalt
(HR)	crno	bijelo	sivo	zeleno	crveno	plavo	zuto	smeđe	ljubičasto	narandasto	nije zauzeto
(BUL)	черен	бял	сив	зелен	червен	син	жълт	кафяв	виолетов	оранжев	свободно
(RO)	negru	alb	gri	verde	roșu	albastru	galben	maro	violet	portocaliu	liber
(RU)	черный	белый	серый	зеленый	красный	голубой	жёлтый	коричневый	пурпурный	оранжевый	свободно
(LT)	juoda	balta	pilka	žalia	raudona	mėlyna	geltona	ruda	purpurinė	oranžinė	laisva
(LV)	melna	balta	pelēka	zaļa	sarkana	zila	dzeltena	brūna	purpur-sarkana	oranža	brīvs
(EST)	must	valge	hall	roheline	punane	sinine	kollane	pruun	purpur-punane	oraanž	vaba
(SLO)	črna	bela	siva	zelena	rdeča	modra	rumena	smeđ	vijoličast	oranžen	ni zasedeno
(SK)	čierny	biely	šedý	zelený	červený	modrý	žltý	hnedý	fialový	pomarančový	neobsadený



10

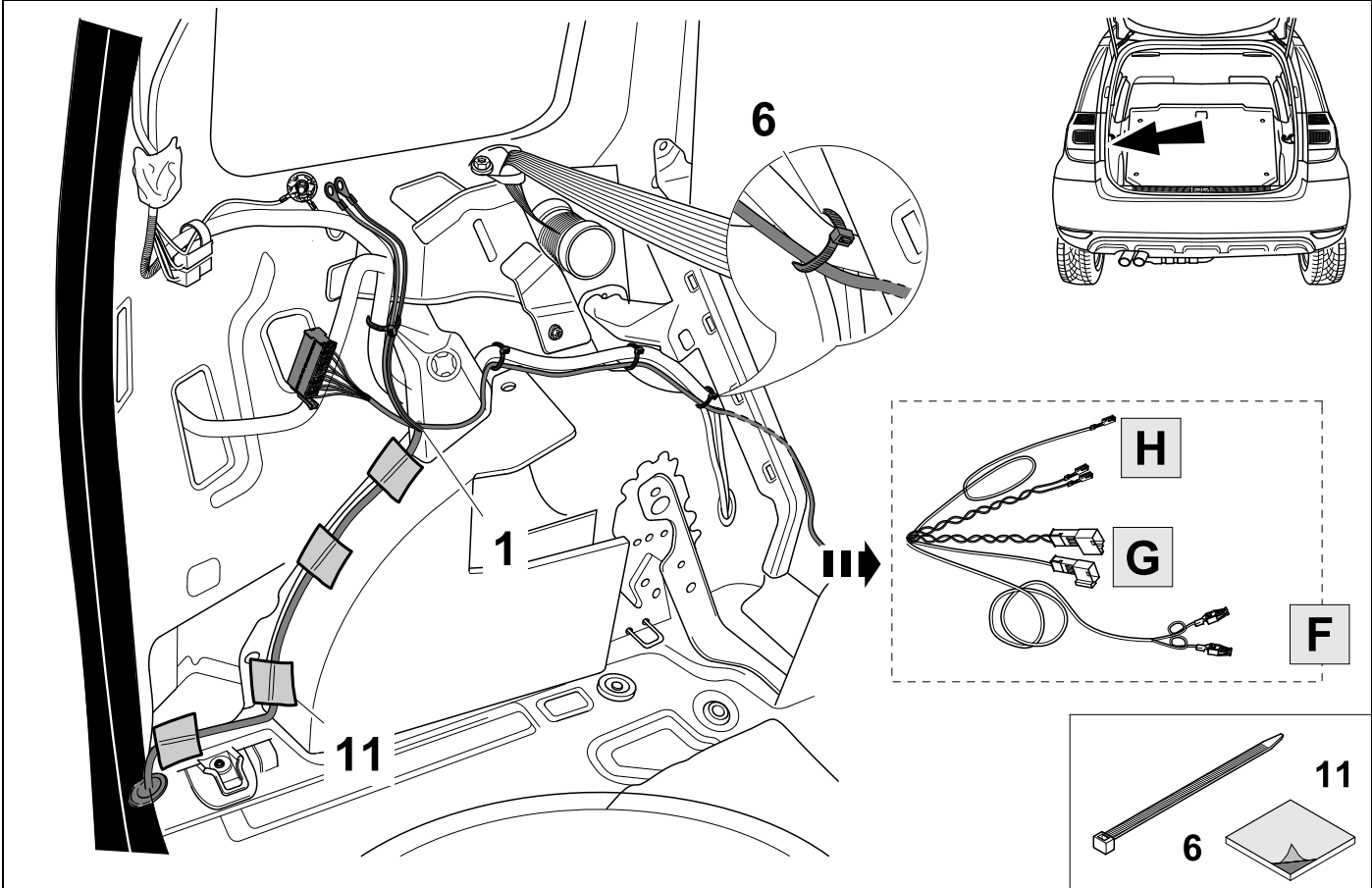

11

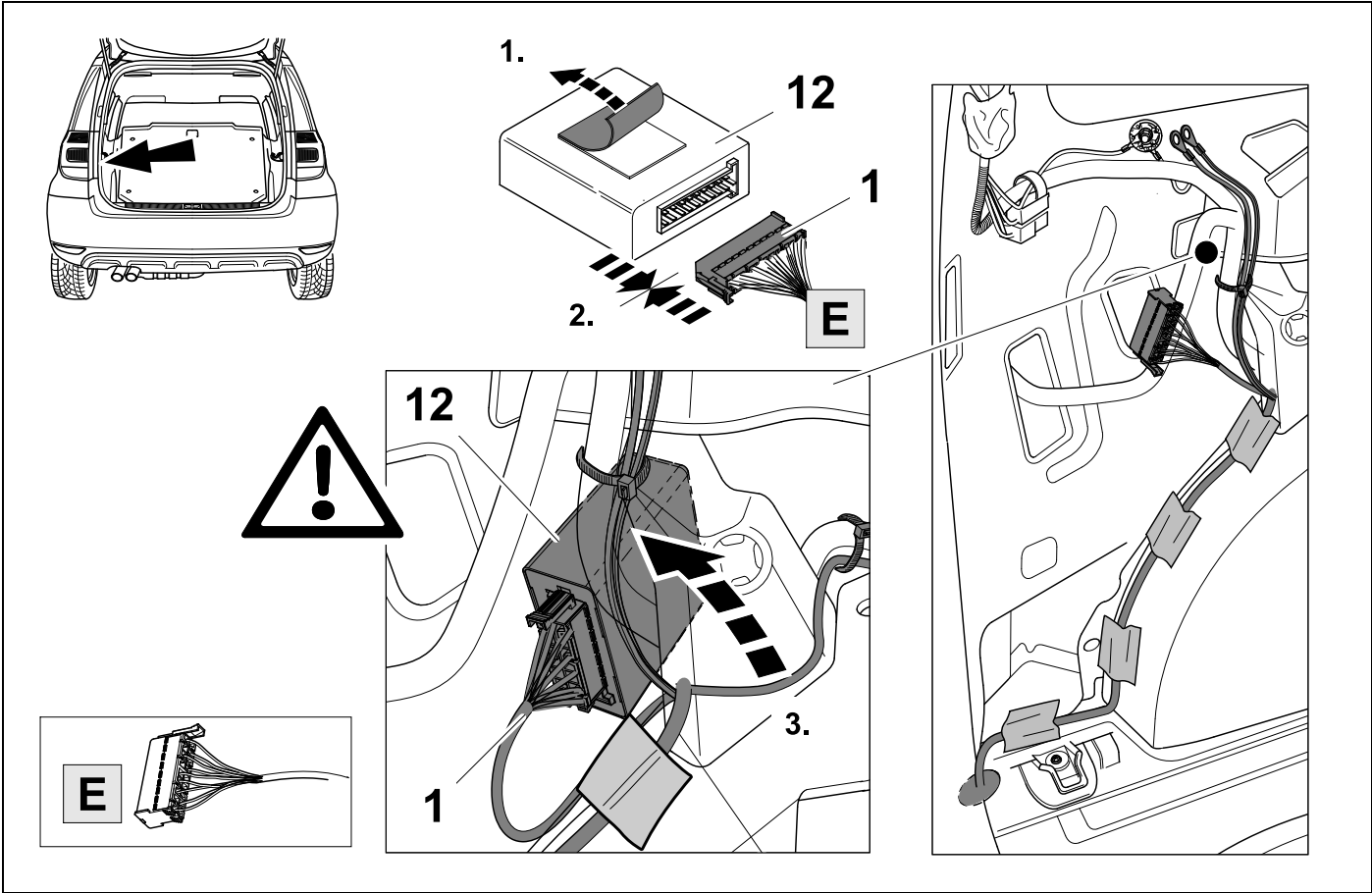

12

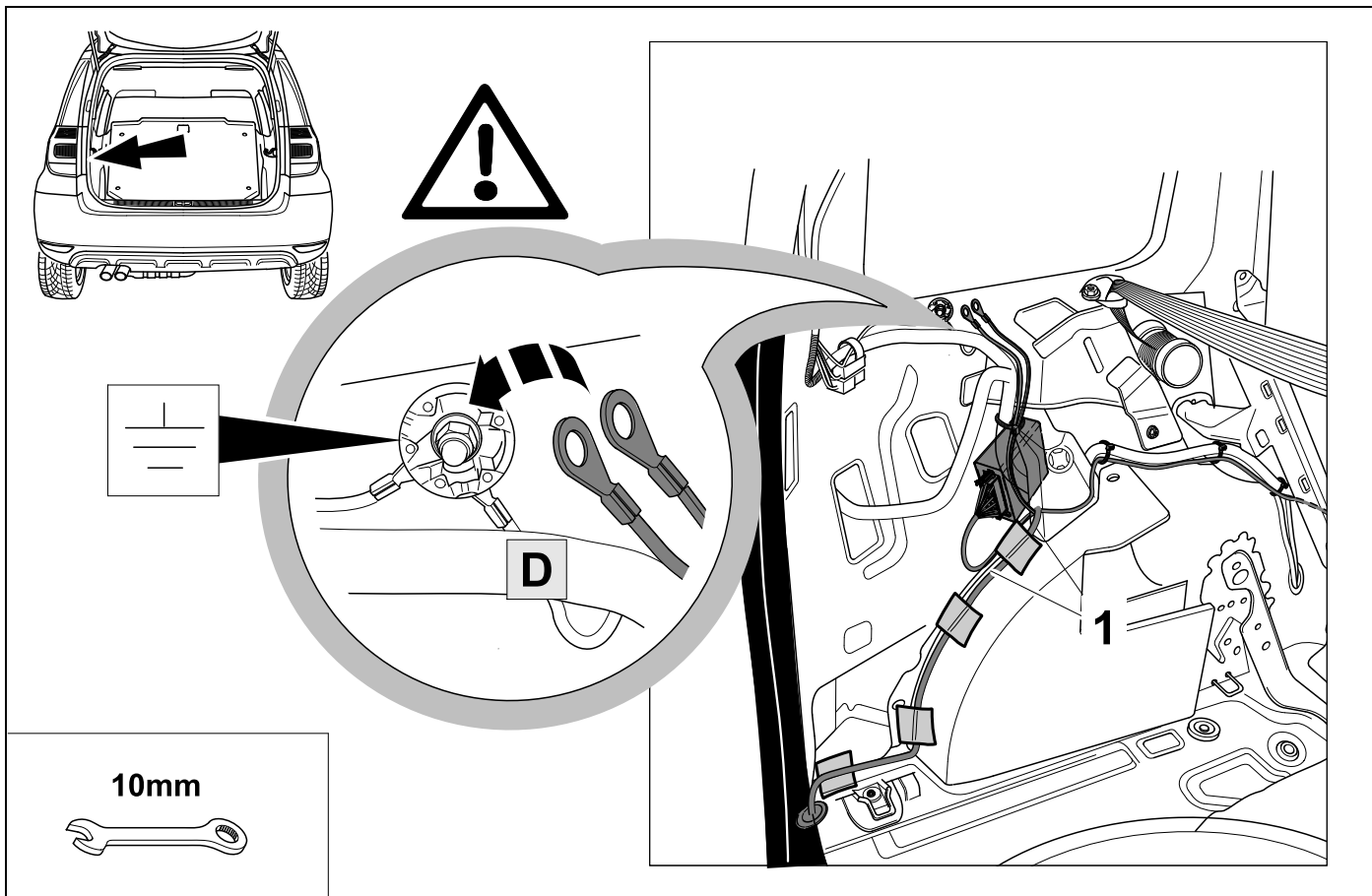

13

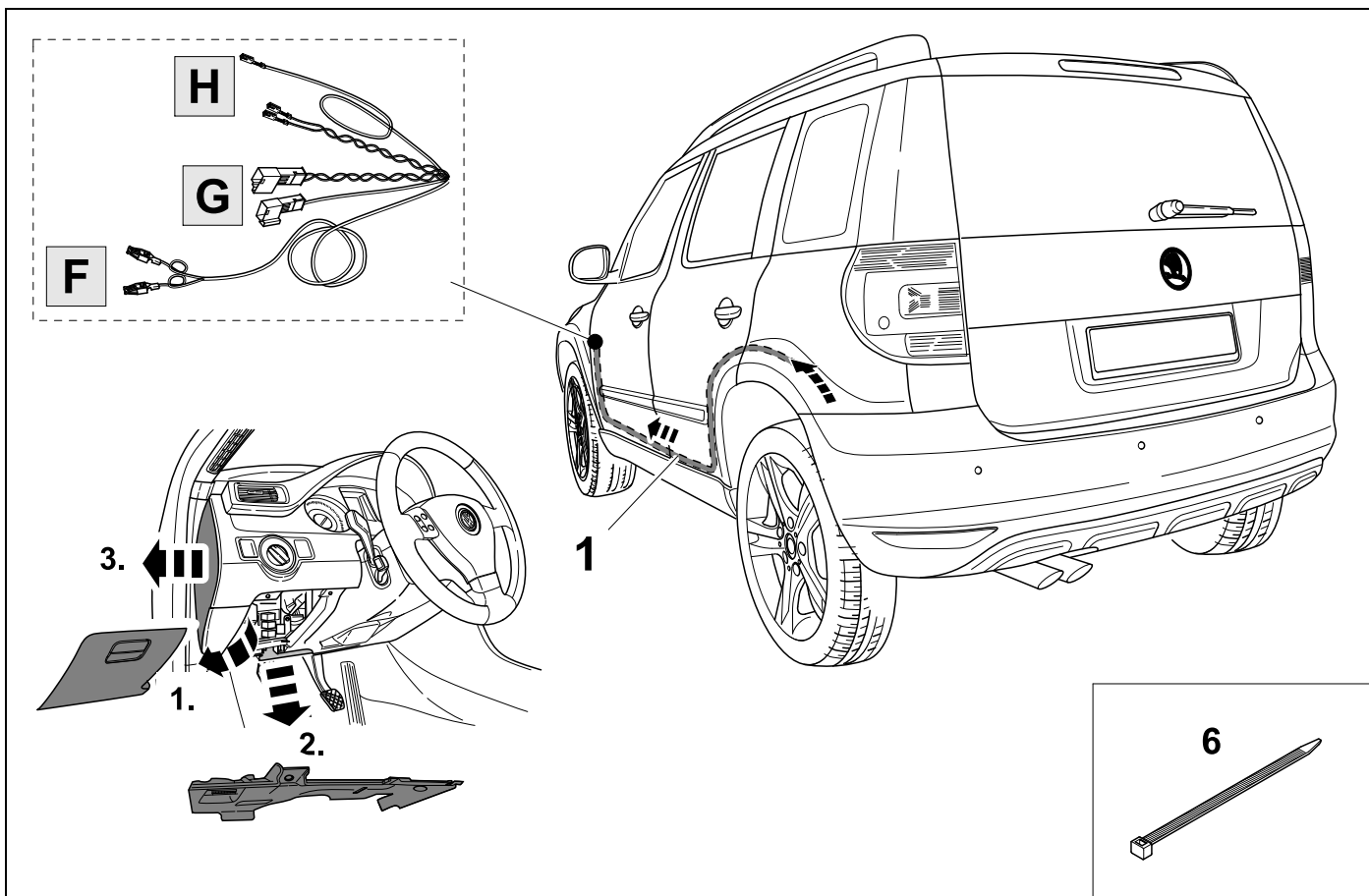

14



9

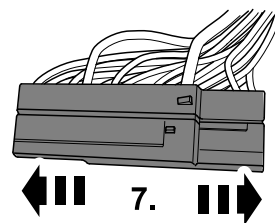
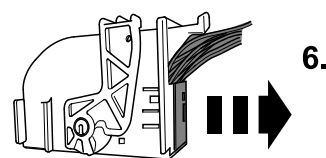
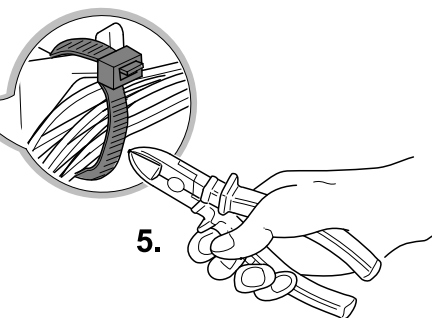
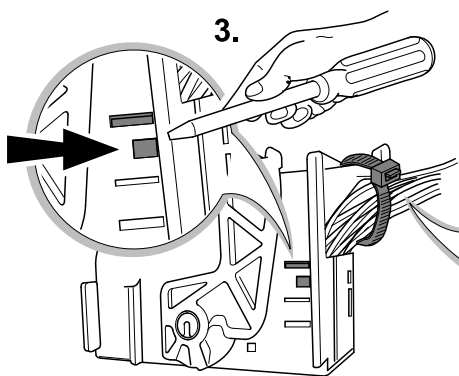
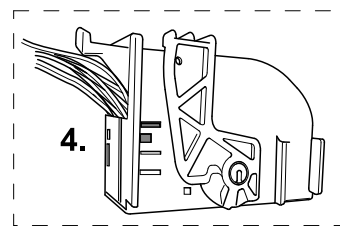
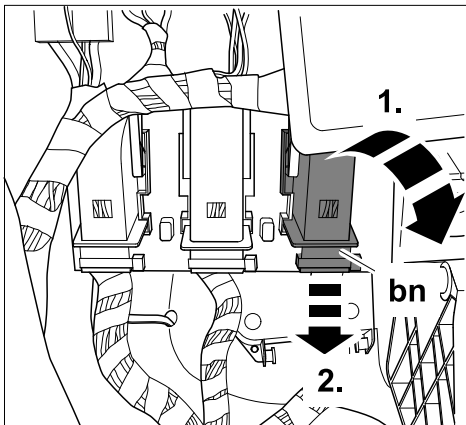
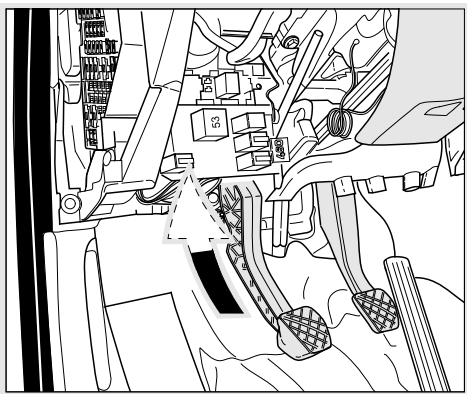

15



9

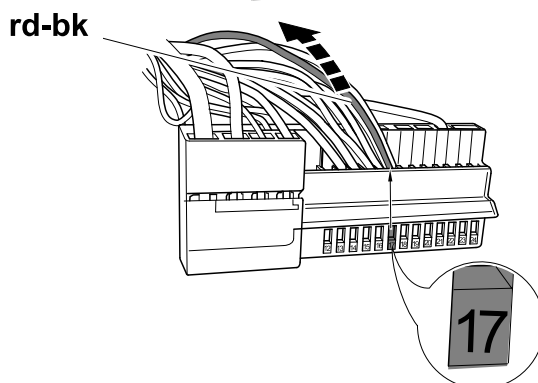
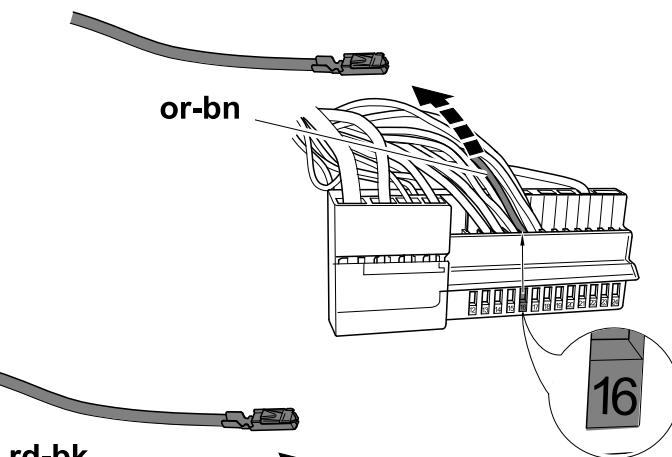
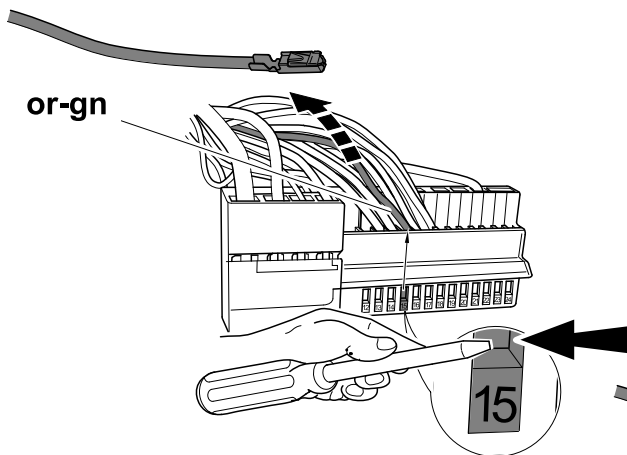

16



9

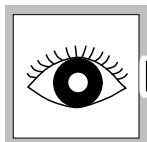

15

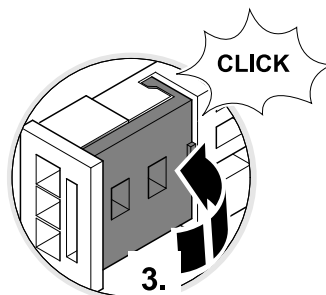
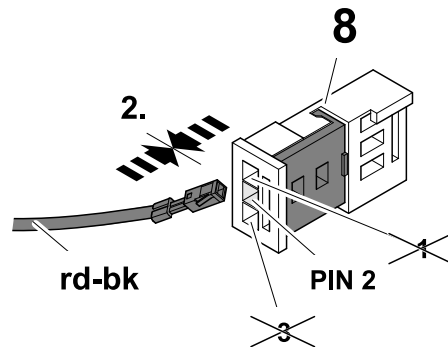
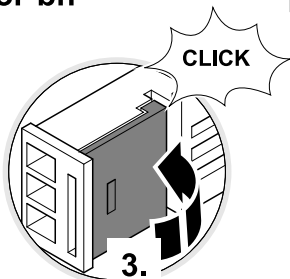
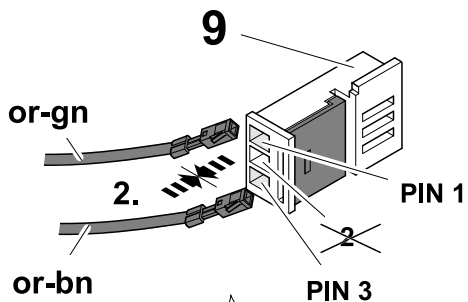
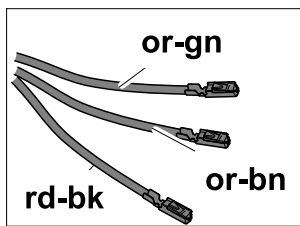

17



9

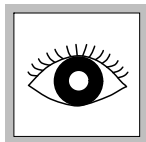
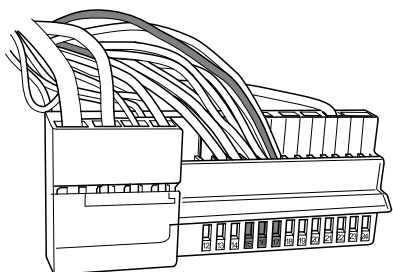

or-gn |||> PIN 15

or-bn |||> PIN 16

ye-bk |||> PIN 17

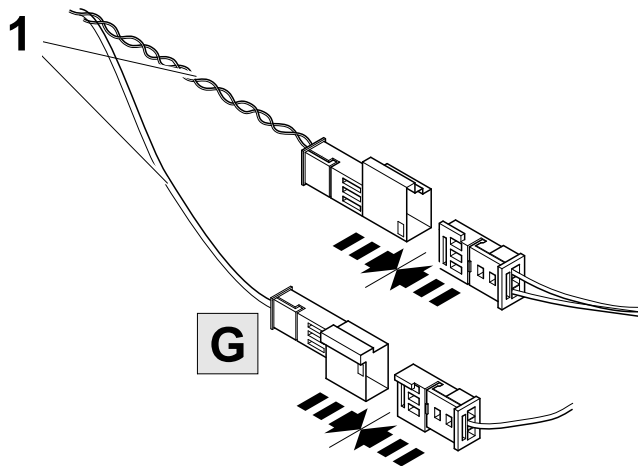
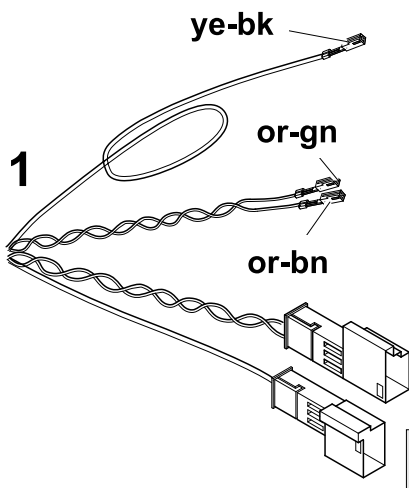

18



9

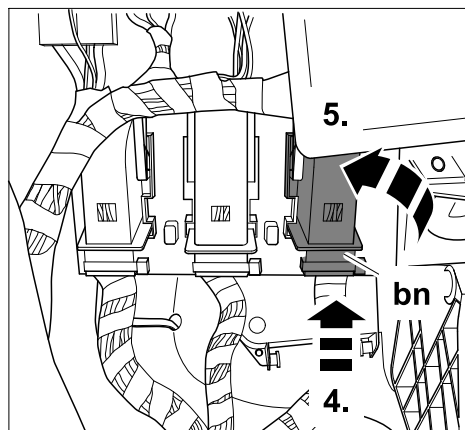
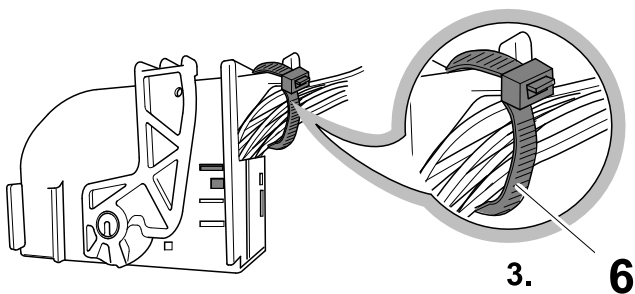
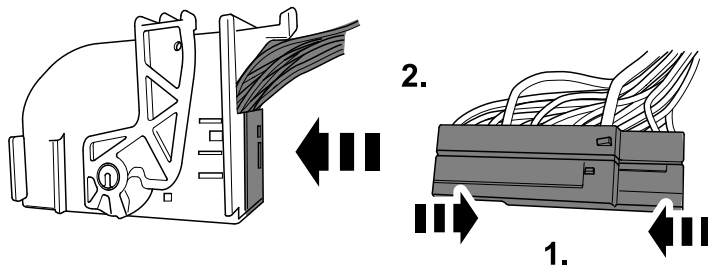
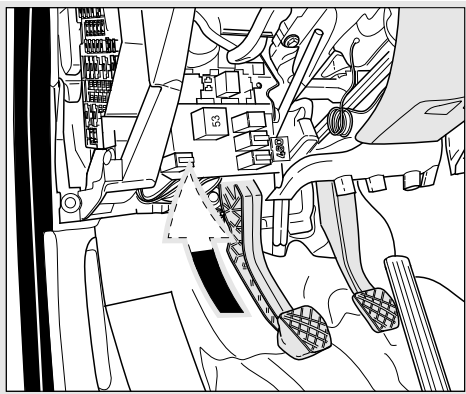

19

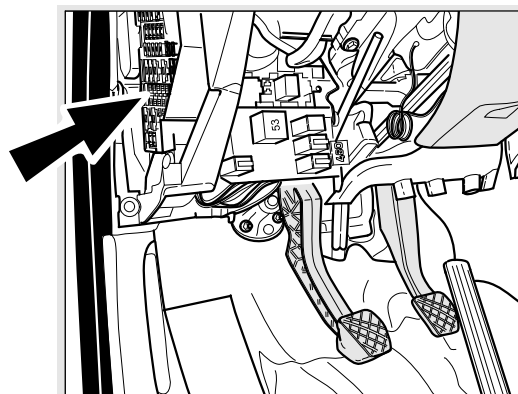
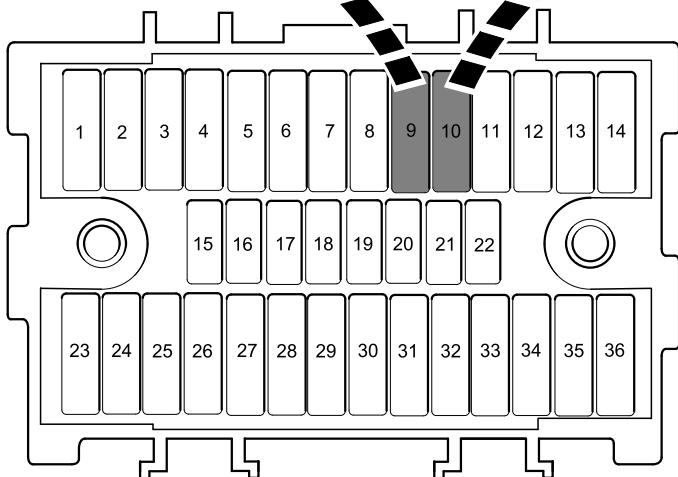
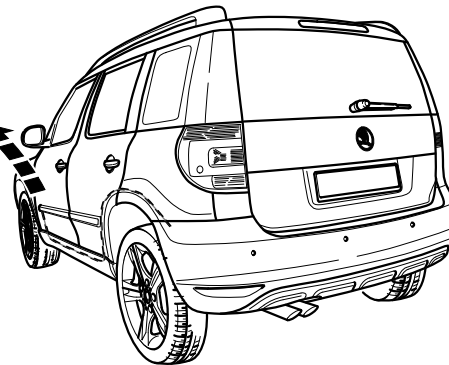
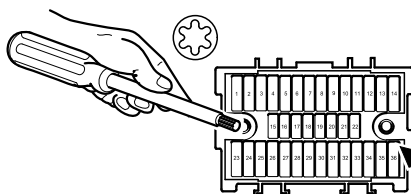
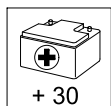

20

👁️ → 9

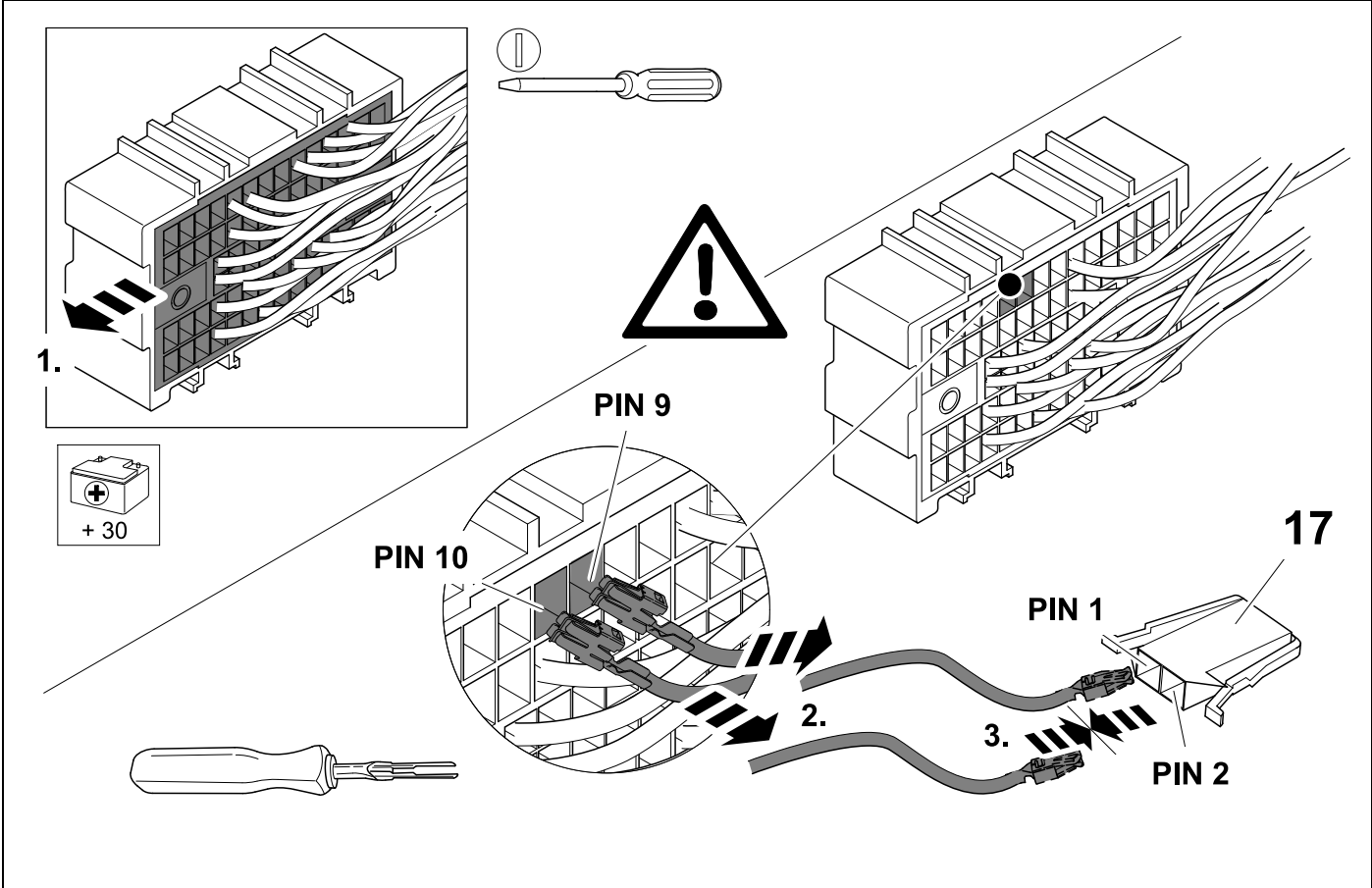

21

👁️ → 9

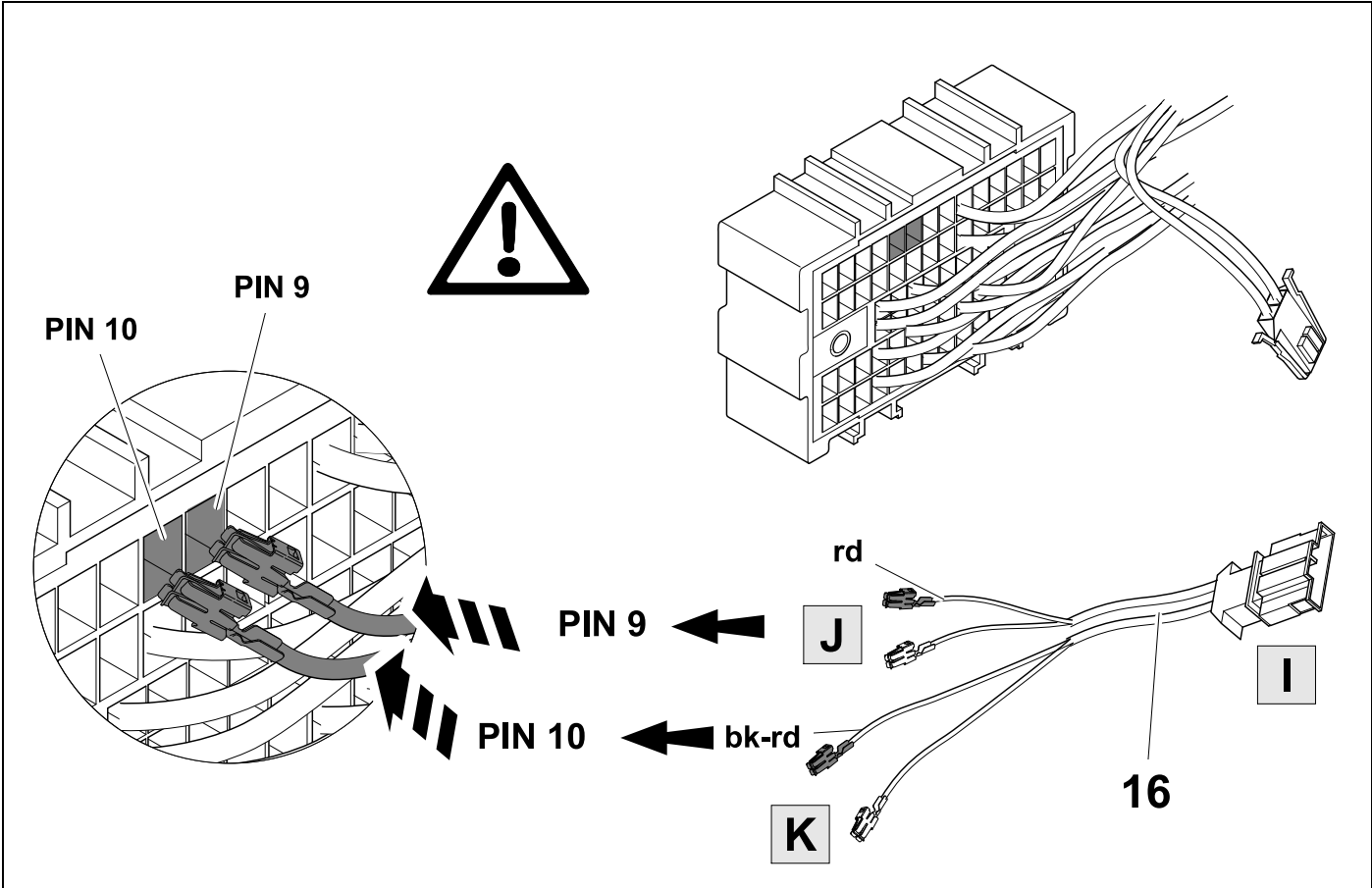

22



30

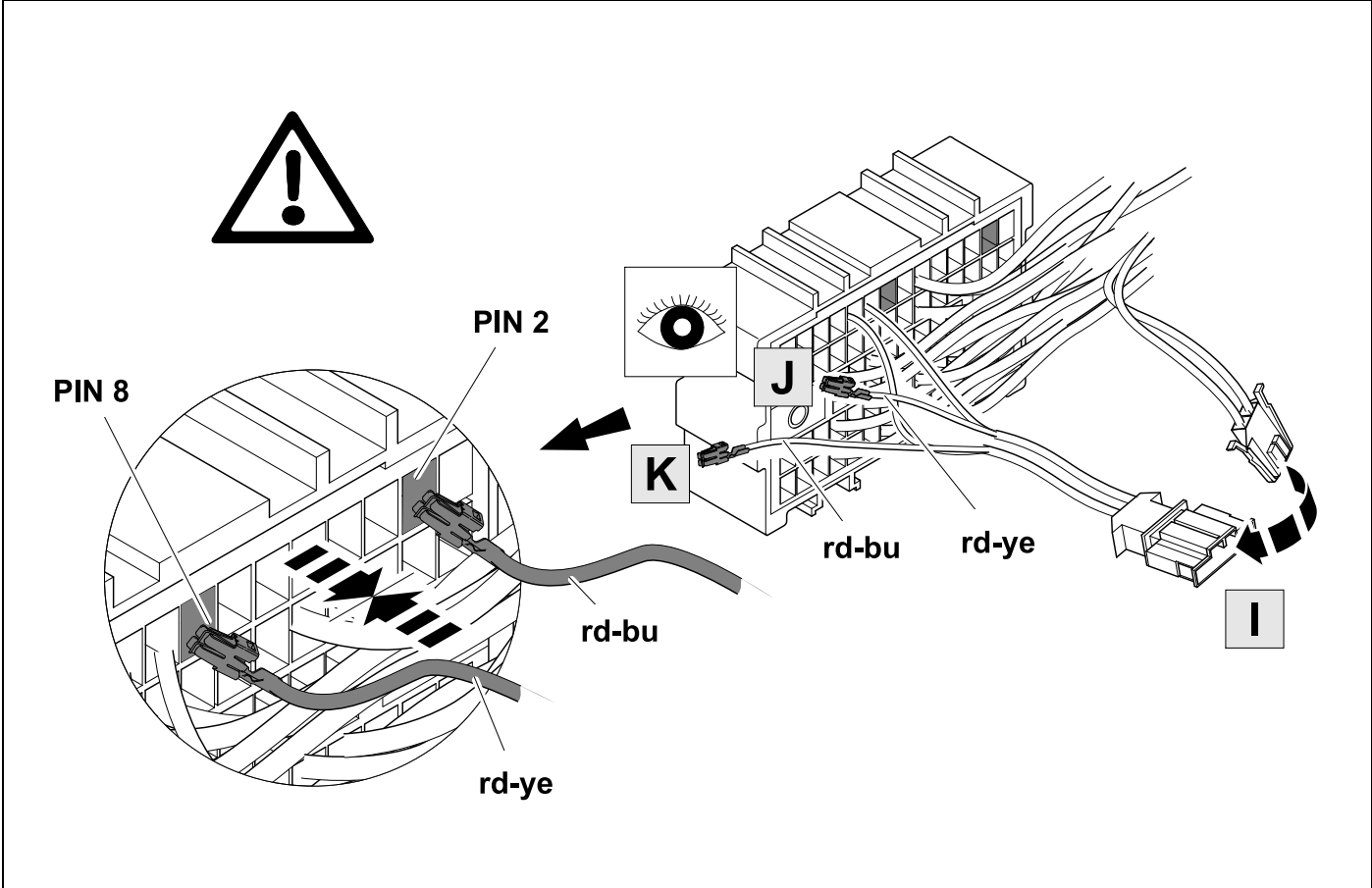

23



30

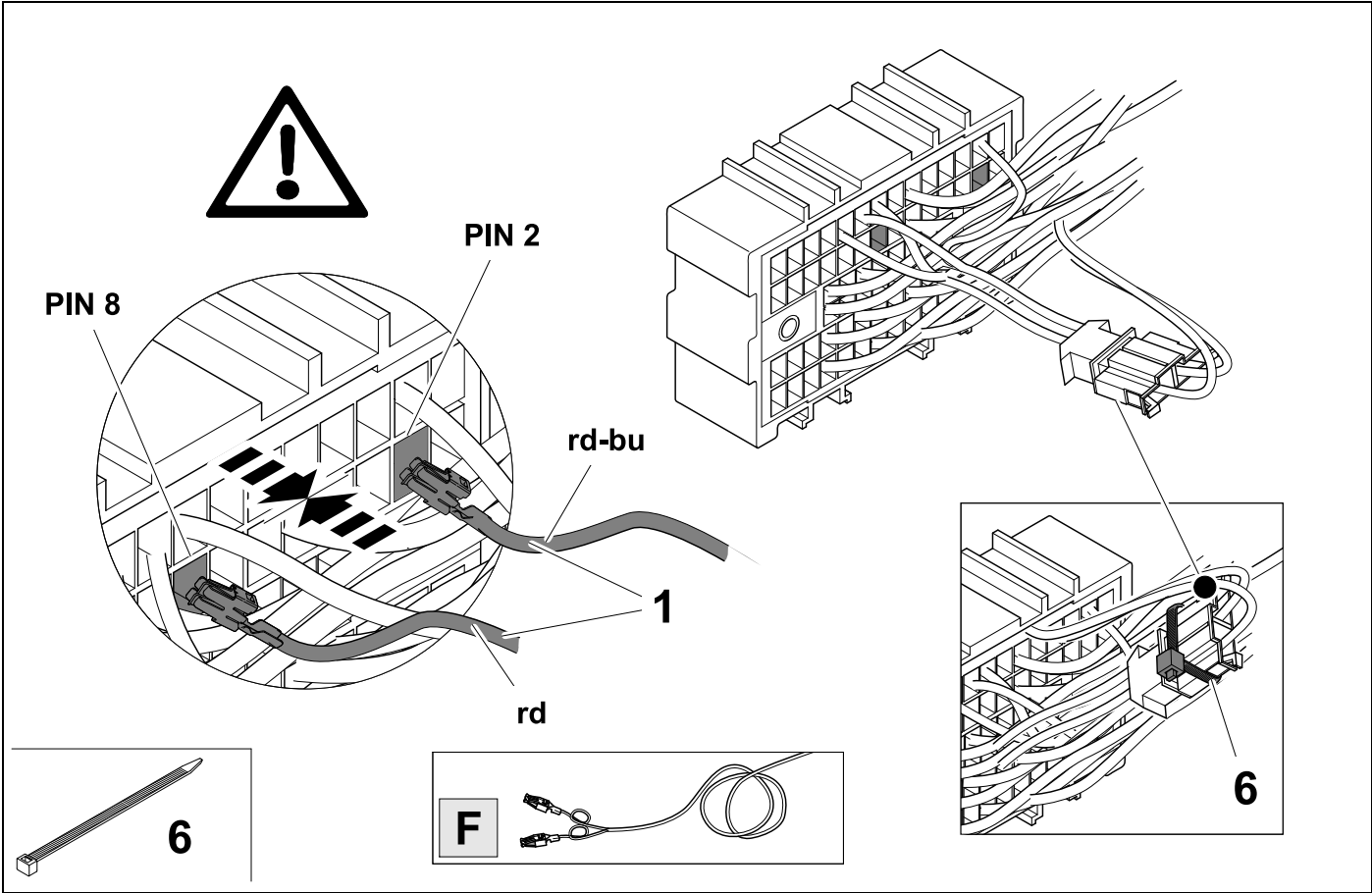

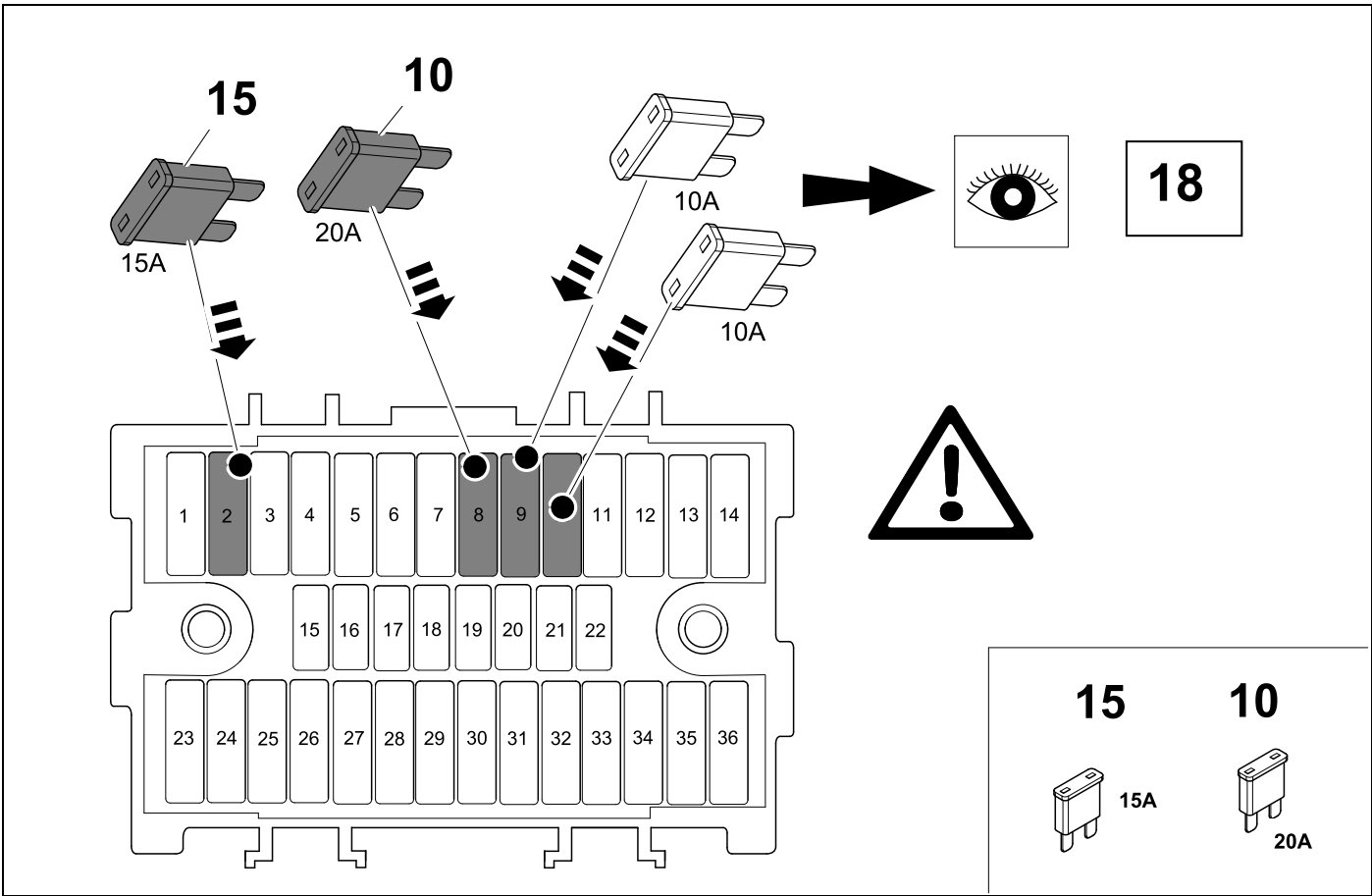



# 25 OPTIONAL

764159

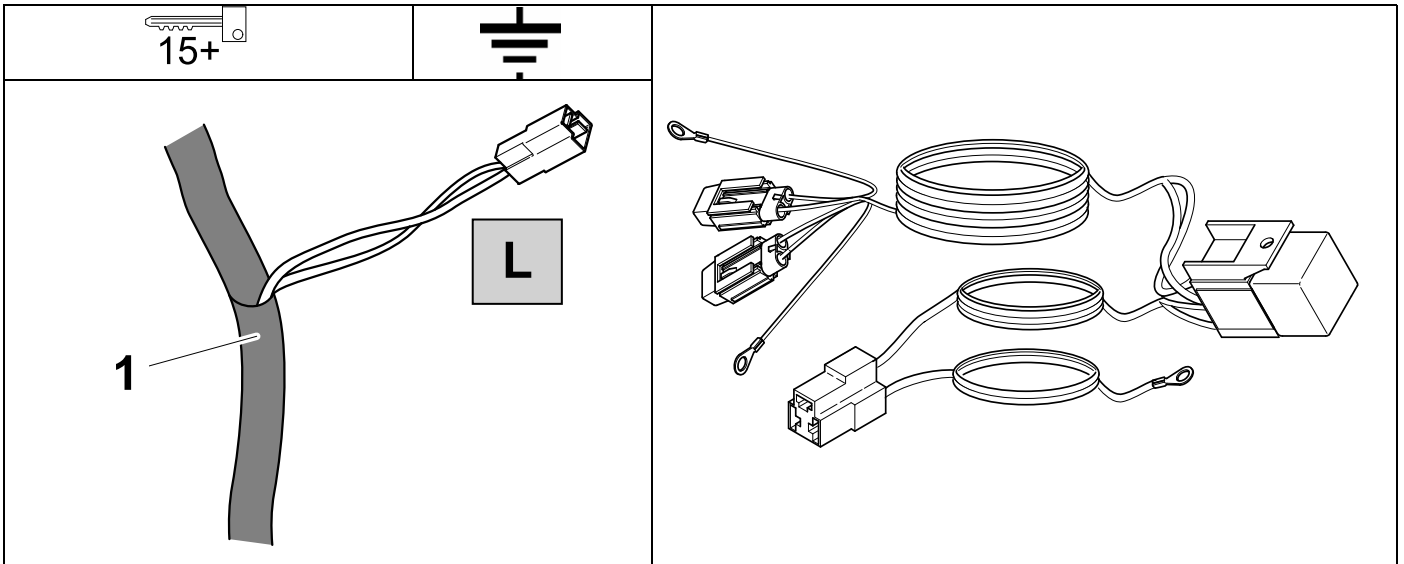

# 26

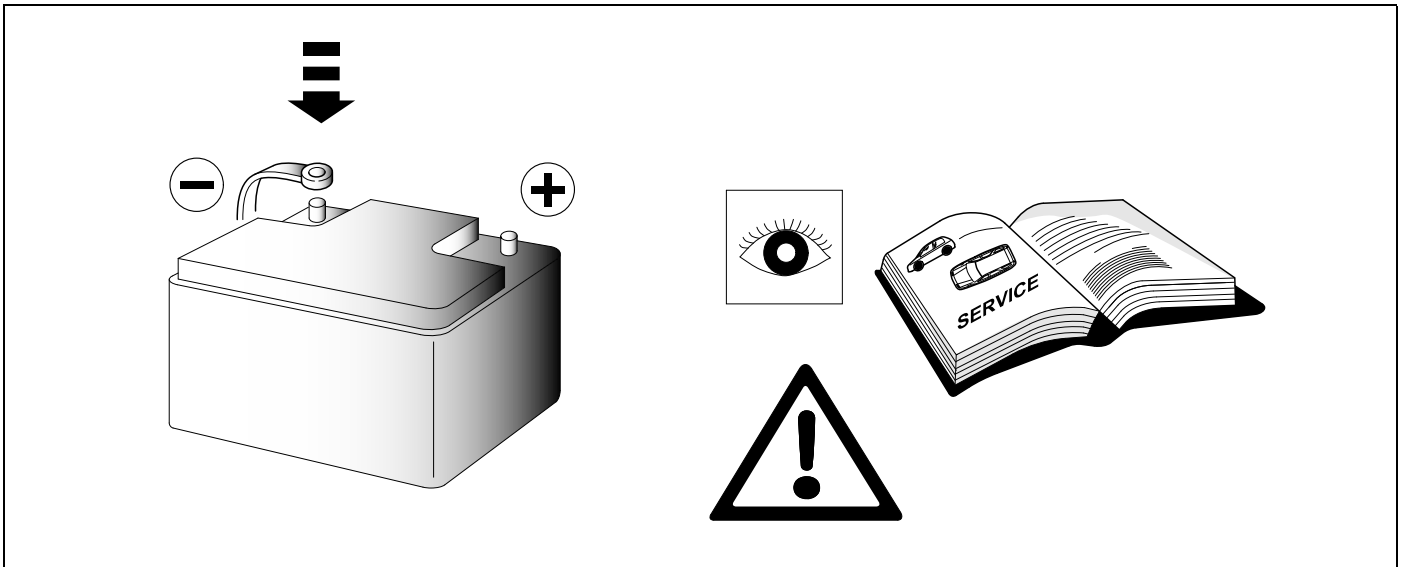

# 27 CHECK

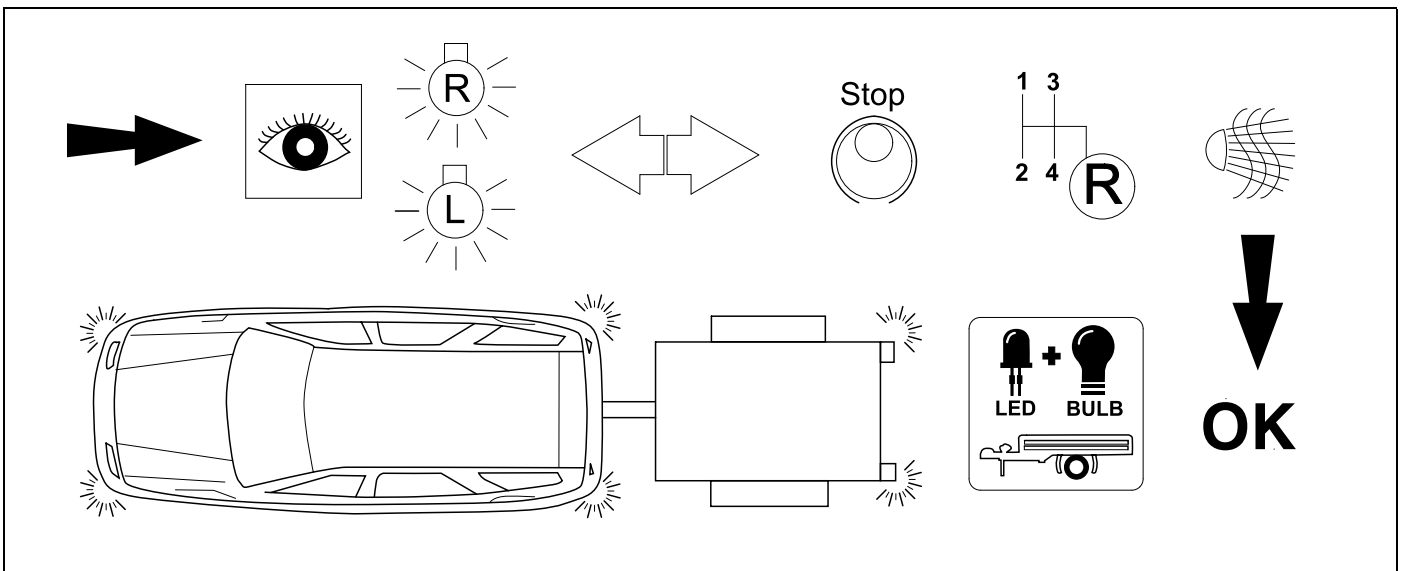

**28** OPTIONAL

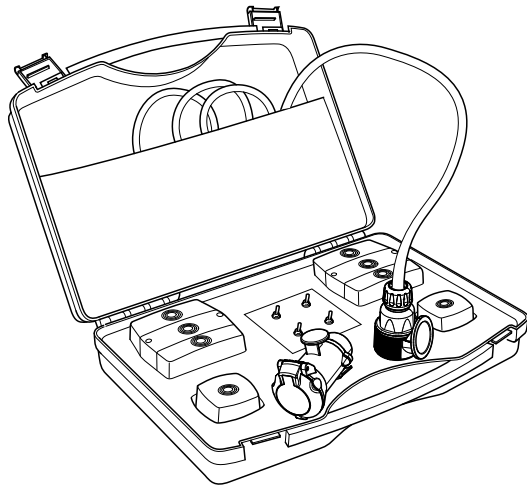

**Trailer Simulator  
for 7p and 13p  
sockets**

**765069**

**29** CHECK

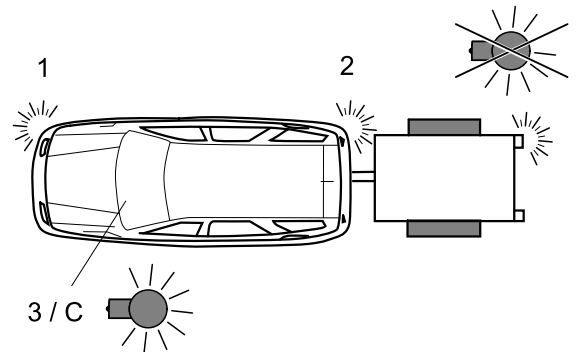
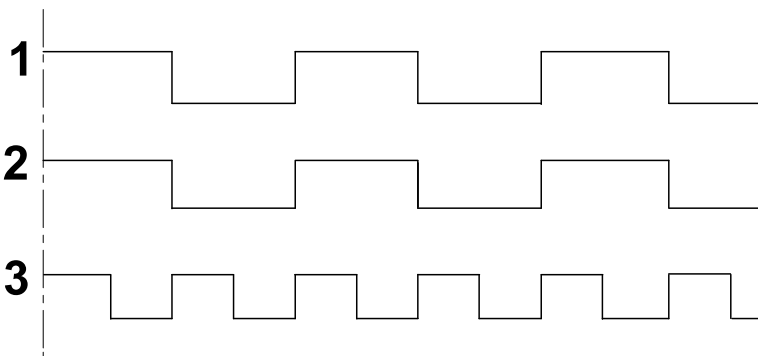

**30** Information Service



**21**

**- 24**

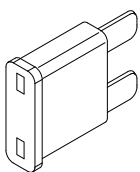

**20A**

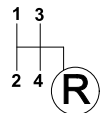
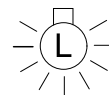
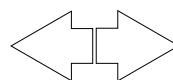
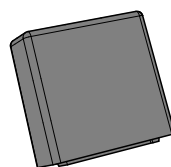
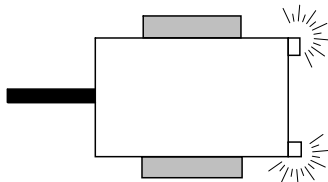

Stop

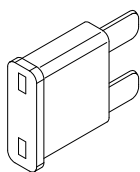
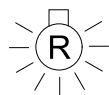

**15A**

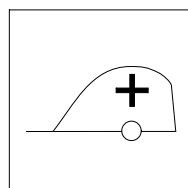
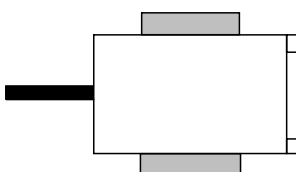

31

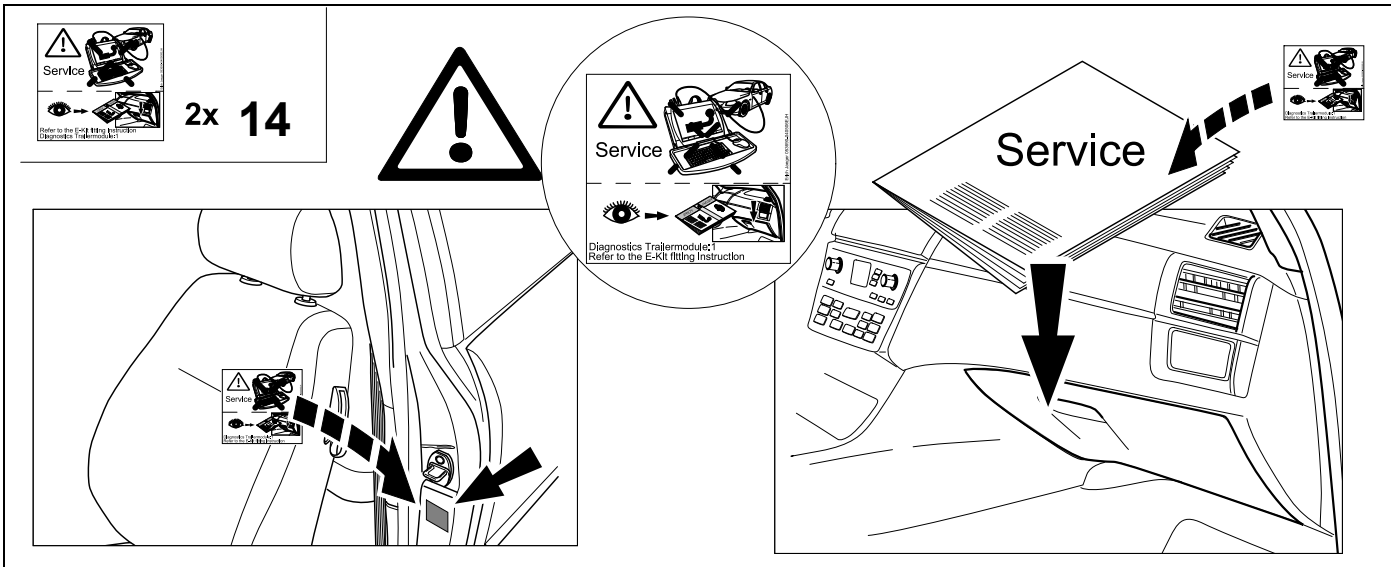

32 OPTIONAL



**BRINK**

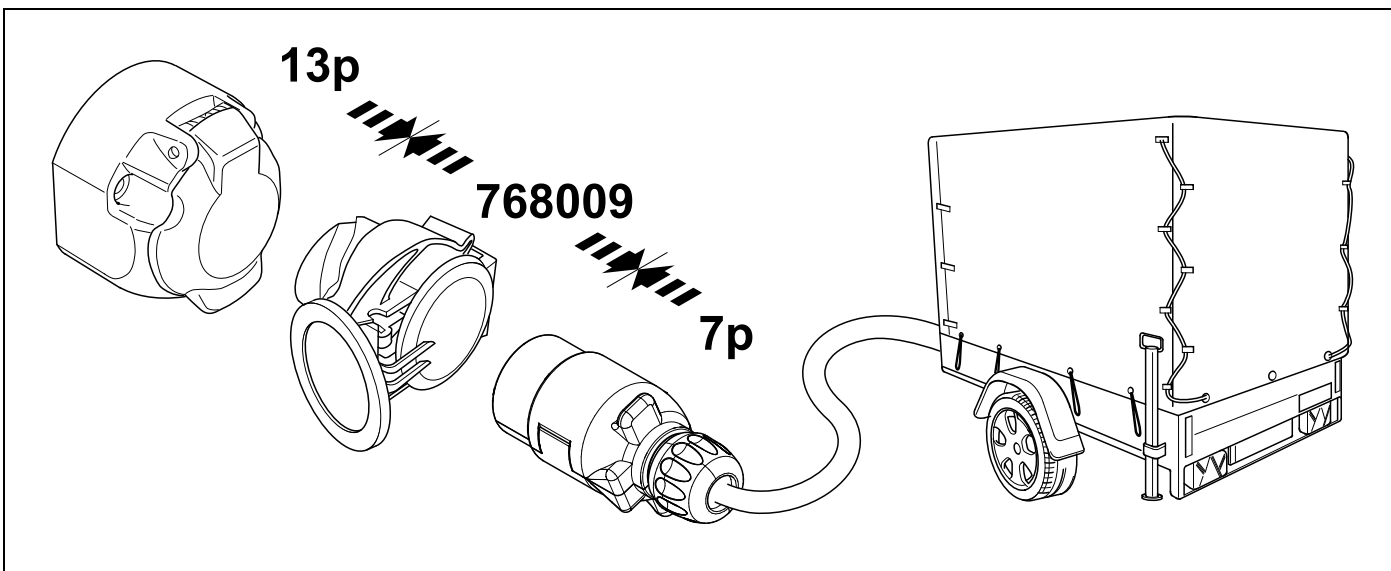

33 PLEASE NOTICE

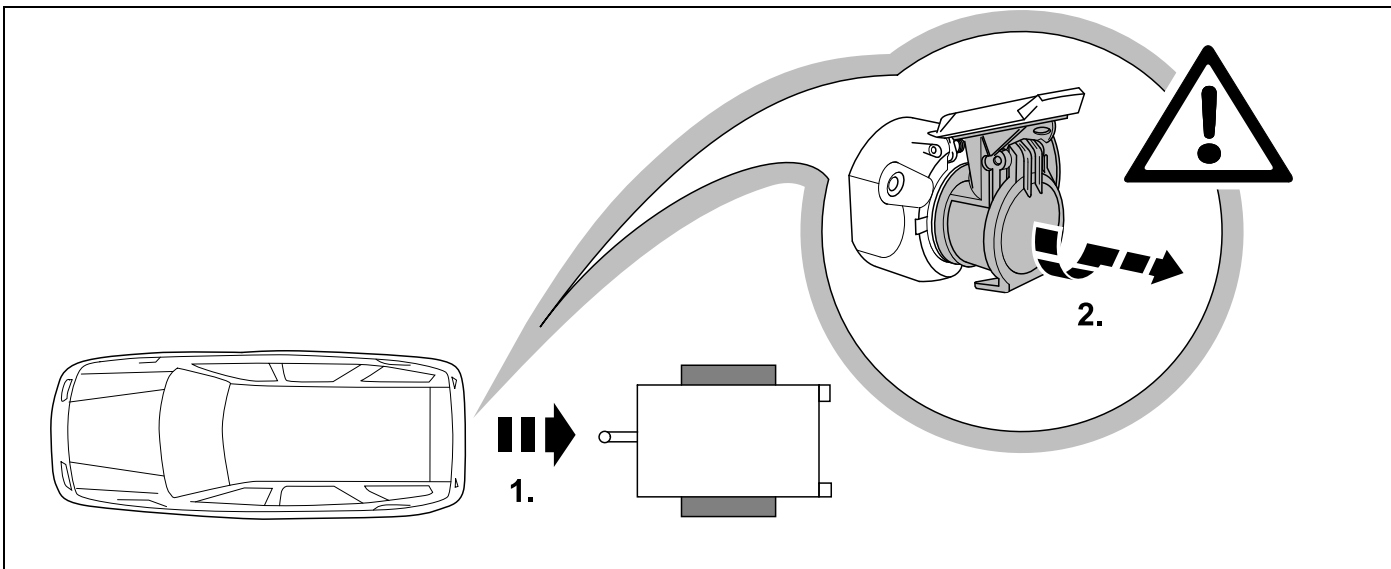

**Need help programming this wiringkit?**

Use Jifeline to program this wiringkit

*Please check the voucher added to this wiringkit and learn how to program this wiringkit with Jifeline.*

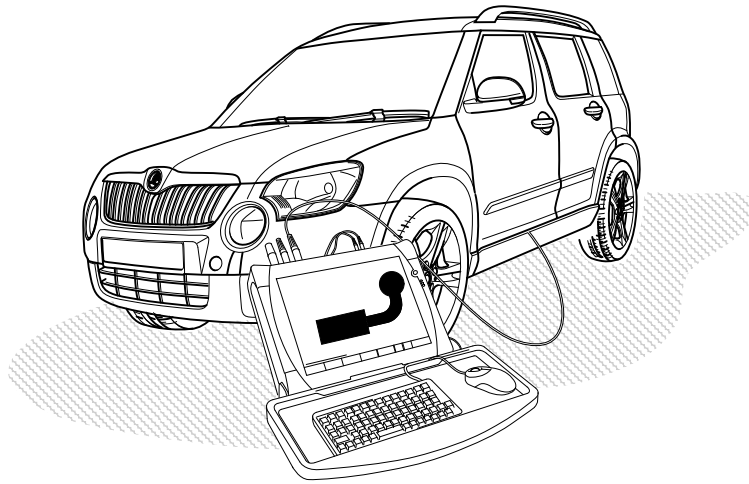

**Codierung bitte wie folgt durchführen:**

- Fahrzeug-Eigendiagnose
- Gateway-Verbauliste
- 19 – Diagnoseinterface für Datenbus
- 007-Codierung (Dienst \$1A) \ Lange Codierung lesen / schreiben
- 69 – Anhängerfunktion ( auf codiert schalten!)

**Fahrzeuge mit Einparkhilfe**

Die automatische Deaktivierung der rückwärtigen Einparkhilfe im Anhängerbetrieb wird durch nachfolgende Codierung des Einparkhilfe-Steuergeräts erreicht:

- Fahrzeug-Eigendiagnose
- Gateway-Verbauliste
- 10 - Einparkhilfe II / Parklenkassistent
- 008 Codierung (Dienst \$22)
- Byte 0 - Bit-Muster xxxxxxx1 (x = die vorhandenen Werte im Eingabefeld übernehmen, dazu Eingabemodus (BIN) einschalten!)
- mit OK bestätigen!

**HINWEIS:**

Sollte sich die Fahrzeug seitige Nebelschlussleuchte nicht automatisch im Anhängerbetrieb abschalten, muss ergänzend zur oben genannten Konfiguration die Zentralelektrik wie folgt codiert werden:

**Fahrzeug Eigendiagnose**

- 09 Elektronische Zentralelektrik
- 007 Codierung (Dienst 1A)
- Bordnetz-SG Codierung lang
- Byte 8 - Bit-Muster **x1xxxxxx** (x = die vorhandenen Werte im Eingabefeld übernehmen, dazu Eingabemodus (BIN) einschalten!)
- mit OK bestätigen!

(D)

**Please effect coding as follows:**

- Vehicle self-diagnosis
- Gateway assembly list
- 19 – diagnosis interface for data bus
- 007-Coding (service \$1A) \ Read / write long coding
- 69 – trailer function ( switch to coded!)

**Vehicles with park assist systems**

The automatic deactivation of the rear park assist system in trailer operation will be effected by means of the subsequent coding of the park assist control unit:

- Vehicle self-diagnosis
- Gateway assembly list
- 10 - park assist system II / parallel park assist
- 008 Coding (service \$22)
- Byte 0 - bit pattern xxxxxxx1 (x = accept the default values in the input field for this purpose activate input mode (BIN))
- confirm with OK !

**NOTE:**

If the vehicle's rear fog lamp does not switch off automatically in trailer mode the following code must be entered in addition to the aforementioned configuration of the central electrical system:

**Vehicle self-diagnosis**

- 09 Electronic central electrical system
- 007 Coding (service 1A)
- Vehicle's electrical system controller coding long
- Byte 8 - bit pattern **x1xxxxxx** (x = accept the default values in the input field for this purpose activate input mode (BIN))
- confirm with OK !

(GB)

**Veillez effectuer le codage comme il suit:**

- autodiagnostic du véhicule
- liste d'assemblage gateway
- 19 – interface de diagnostic pour bus de données
- 007-codage (service \$1A) \ lire / écrire un code long
- 69 – mode remorque ( commuter à encodé)

**Véhicules avec système d'aide au parking**

L'aide au parking arrière est désactivée automatiquement dans le mode remorqu par le codage suivant du dispositif decommande du système d'aide au parking:

- autodiagnostic du véhicule
- liste d'assemblage gateway
- 10 - système d'aide au parking II / parallel park assist
- 008 Codage (service \$22)
- Modèle Byte 0 bits xxxxxxx1 (x = reprendre les valeurs dans le champ de saisie et allumer le mode saisie (BIN))
- Confirmer en appuyant sur OK

**AVERTISSEMENT:**

Si le feu brouillard arrière monté sur le véhicule ne s'éteint pas automatiquement durant le fonctionnement avec remorque, il faut completer la configuration ci-dessus en codant l'électricité centrale comme suit:

**autodiagnostic du véhicule**

- 09 Électricité centrale électronique
- 007 Codage (service 1A)
- Codage dispositif de commande circuit de bord long
- Modèle Byte 8 bits **x1xxxxxx** (x = reprendre les valeurs dans le champ de saisie et allumer le mode saisie (BIN))
- Confirmer en appuyant sur OK!

(F)

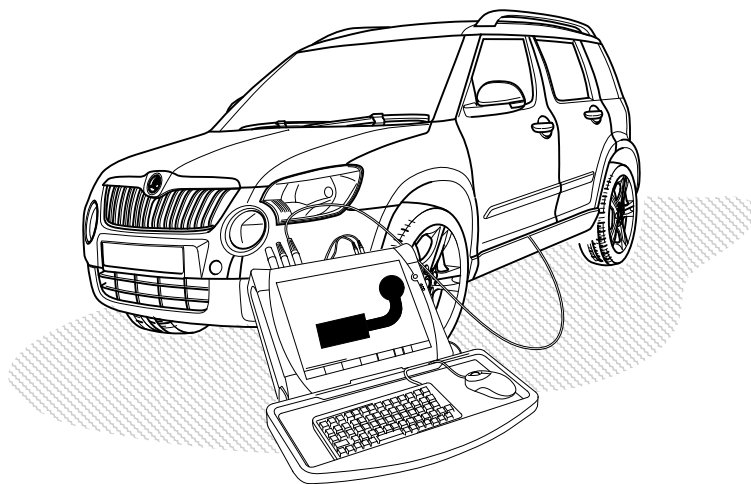

**Si prega di eseguire la codifica come segue:**

- Autodiagnosi del veicolo
- Lista del Gateway
- 19 – Interfaccia di diagnosi per il data bus
- 007-codifica (servizio \$1A) \ Lettura e scrittura di codici lunghi
- 69 – Funzione rimorchio (commutare su codificato!)

**Veicoli con sensori di parcheggio**

La disattivazione automatica dei sensori di parcheggio posteriori quando è attaccato un rimorchio si ottiene attraverso la seguente programmazione della centralina di controllo dei sensori:

- Autodiagnosi del veicolo
- Lista del Gateway
- 10 - sensori di parcheggio II / parallel park assist
- 008 Codifica (servizio \$22)
- Byte 0 – modello Bit xxxxxxx1 (x = applicare i valori disponibili nel campo di immissione, attivando il modo di immissione (BIN))
- Confermare con OK!

**AVVERTENZA:**

Se il retronebbia del veicolo non dovesse spegnersi automaticamente nell'esercizio con rimorchio, oltre alla configurazione indicata sopra, è necessario codificare l'impianto elettrico centrale come segue:

**Autodiagnosi del veicolo**

- 09 Impianto elettrico centrale elettronico
- 007 Codifica (servizio 1A)
- Codifica centralina rete di bordo lunga
- Byte 8 – modello Bit x1xxxxxx (x = applicare i valori disponibili nel campo di immissione, attivando il modo di immissione (BIN))
- Confermare con OK!

**Codificar del siguiente modo:**

- Autodiagnóstico del vehículo
- Lista Gateway
- 19 - Interfaz de diagnóstico para bus de datos
- 007-Codificación (servicio \$1A) \ Leer / escribir la codificación larga
- 69 - Función del remolque (codificación)

**Veículos con sistema de ayuda para el aparcamiento**

En vehículos con sistema de ayuda para el aparcamiento (PDC) se debe codificar la unidad de control PDC del siguiente modo:

- Autodiagnóstico vehículo
- Lista Gateway
- 10 - ayuda al aparcamiento II / parallel park assist
- 008 Codificación (servicio \$22)
- Byte tipo 0 bitios xxxxxxx1 (x = introducir los valores existentes en el campo de entrada, ¡activar al respecto el modo de introducción (BIN))
- ¡Confirmar con OK!

**NOTA:**

En caso de que la luz antiniebla trasera del vehículo no se apague automáticamente en el servicio con remolque, deberá codificarse el sistema eléctrico central adicionalmente a la configuración arriba mencionada del siguiente modo:

**Autodiagnóstico vehículo**

- 09 Sistema eléctrico central electrónico
- 007 Codificación (servicio 1A)
- Sistema de alimentación de a bordo # Regulador codificación larga
- Byte tipo 8 bitios x1xxxxxx (x = introducir los valores existentes en el campo de entrada, ¡activar al respecto el modo de introducción (BIN))
- ¡Confirmar con OK!

**Gelieve codering als volgt door te voeren:**

- Eigen diagnose voertuig
- Gateway-inbouwlijst
- 19 – diagnose-interface für gegenvensinvoerbus
- 007-Codering (dienst \$1A) \ Lange codering lezen/schrijven
- 69 – aanhangwagenfunctie (op “Gecodeerd” schakelen!)

**Voertuigen met parkeerhulp**

Bij voertuigen met parkeerhulp dient de regeleenheid van de parkeerhulp als volgt te worden gecodeerd:

- Eigen diagnose voertuig
- Gateway-inbouwlijst
- 10 - parkeerhulp II / Park Assist
- 008 Codering (dienst \$22)
- Byte 0 - bitpatroon xxxxxxx1 (x = de aanwezige waarden in het invoerveld overnemen, hiervoor invoermodus (BIN) inschakelen!)
- met OK bevestigen!

**AANWIJZING!**

Mocht de mistlamp op het voertuig tijdens gebruik van de aanhanger niet automatisch worden uitgeschakeld, dan moet las aanvulling op de bovengenoemde configuratie de centrale elektrische installatie als volgt worden gecodeerd:

**Zelfdiagnose voertuig**

- 09 Elektronische centrale elektrische installatie
- 007 Codering (dienst 1A)
- Elektrische installatie-SG codering lang
- Byte 8 - bitpatroon x1xxxxxx (x = de aanwezige waarden in het invoerveld vernemen, dan invoermodus (BIN) inschakelen!)
- Met OK bevestigen!

# Status LED für Eigendiagnose

# Status LED for self-diagnosis

## Operation support

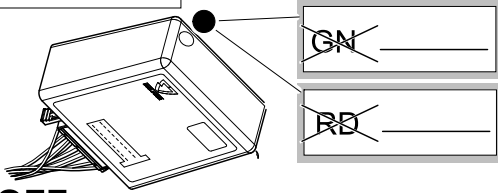
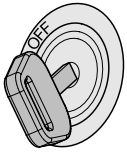

No CAN-Data = Standby / Sleepmode

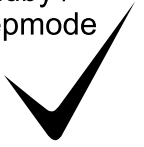

Ignition OFF

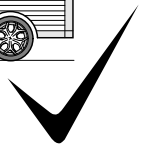
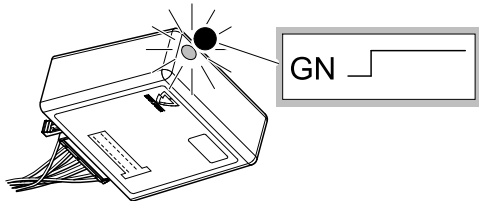

Ignition ON

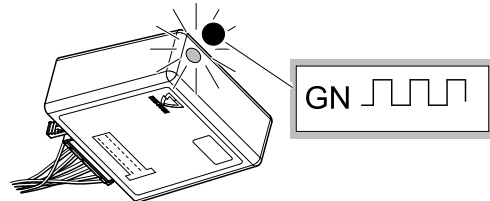

Ignition ON

## Failure support

CAN-Data Wire 1x max. 5 min.

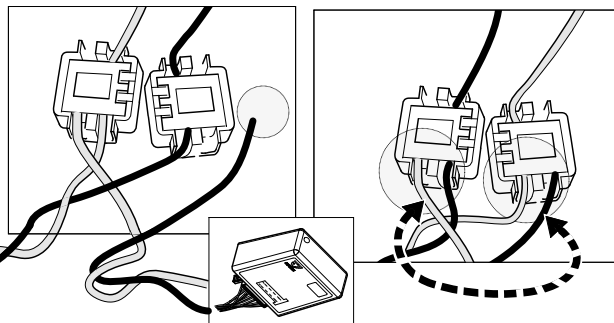
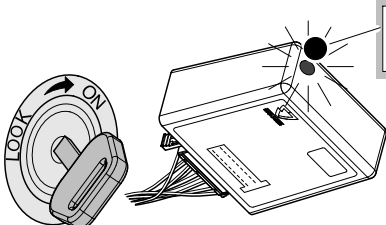

Ignition ON

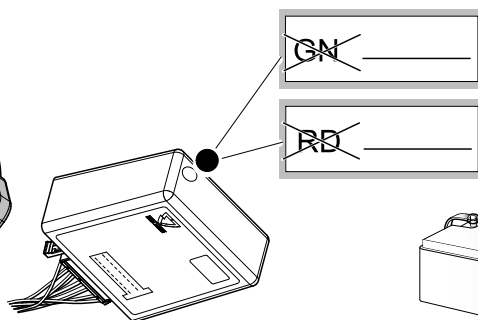
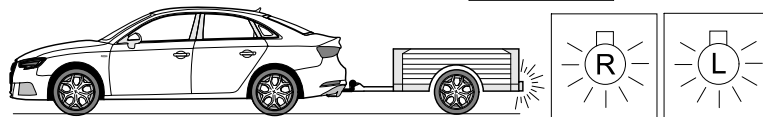

+30 PIN 17 oder / or PIN 1 31

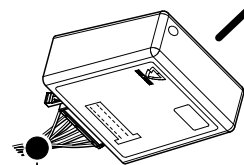
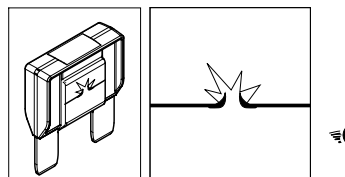
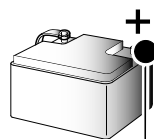

Ignition ON



<p><b>(D)</b> Änderungen bezüglich Konstruktion, Ausstattung Farbe sowie Irrtum vorbehalten. Angaben und Abbildungen unverbindlich</p>	<p><b>(PL)</b> Zastrzega się prawo do zmian dot. konstrukcji, wykończenia, kolorystyki oraz pomyłek. Dane i ilustracje niewiążące.</p>
<p><b>(GB)</b> Subject to change in terms of construction, equipment and colour, and may contain errors. The information and illustrations are non-binding.</p>	<p><b>(TR)</b> Tasarım, donanım ve renk bakımından değişiklik yapma hakkı ve hata ve eksiklik mahfuzdur. Veriler ve resimler bağlayıcı değildir.</p>
<p><b>(F)</b> Sous réserve de modifications de la construction, de l'équipement, de la couleur et sous réserve d'erreurs. Les indications et les illustrations sont sans engagement.</p>	<p><b>(H)</b> A szerkezet, a kivitelt és a szín változtatása, valamint a változások joga fenntartva. Az adatok és az ábrák nem kötelező érvényűek.</p>
<p><b>(NL)</b> Wijzigingen met betrekking tot constructie, uitvoering en kleur evenals vergissingen voorbehouden. Gegevens en afbeeldingen niet bindend.</p>	<p><b>(HR)</b> Pravo promjena u svezi konstrukcije, opreme, boje kao i zabune oridžavamo. Podaci i ilustracije su neobavezne.</p>
<p><b>(DK)</b> Ændringer med hensyn til konstruktion, udstyr, farver samt fejl forbeholdes. Oplysninger og illustrationer er uforpligtende.</p>	<p><b>(BUL)</b> Запазени права по отношение на конструкцията, обзавеждането, цвета и грешки. Данните и изображенията не са обвързващи.</p>
<p><b>(N)</b> Endringer angående konstruksjon, utstyr, farge og feiltagelse forbeholdes. Opplysninger og illustrasjoner uforbindtlig.</p>	<p><b>(RO)</b> Ne rezervăm dreptul unor modificări ale construcției, dotării, culorii și dreptul la erori Datele indicate și imaginile sunt orientative.</p>
<p><b>(S)</b> Med reservation för ändringar vad det gäller konstruktion, utrustning, färg samt för misstag. Uppgifterna och bilderna är inte bindande.</p>	<p><b>(RU)</b> Права на внесение изменений относительно конструкции, оснащения, окраски, а также на ошибки сохраняются. Данные и иллюстрации имеют примерный характер.</p>
<p><b>(FIN)</b> Pidätämme oikeuden rakennetta, varustusta, väriä koskeviin sekä erehdyksestä johtuviin muutoksiin. Tiedot ja kuvat eivätkä ole sitovia.</p>	<p><b>(LT)</b> Pasiliekaama konstrukcijos, įrangos bei reikmenų, spalvos pakeitimų ir klaidų teisė. Duomenys ir iliustracijos neįpareigojantys.</p>
<p><b>(I)</b> Con riserva di modifiche relative a progettazione, dotazione, colore ed errori. Le indicazioni e figure sono fornite senza impegno.</p>	<p><b>(LV)</b> Tiek paturētas tiesības uz konstrukcijas, iekārtu, krāsu izmaiņām, kā arī kļūdīšanās. Dati un attēli bez saistībām.</p>
<p><b>(E)</b> Reservadas las modificaciones respecto a diseño, equipamiento, color, así como error. Indicaciones y figuras sin compromiso.</p>	<p><b>(EST)</b> Konstruktsiooni, varustuse ja võervi osas muudatused ning eksimine lubatud. Andmed ja joonised on mittesiduvad.</p>
<p><b>(P)</b> Reservamos o direito de alterações relativamente ao desenho, equipamento, cor, bem como de erro. Os dados e as gravuras não implicam compromisso da nossa parte.</p>	<p><b>(SLO)</b> Zadržana pravica do sprememb glede konstrukcije, opreme, barve ter pomote. Podatki in slike so neobvezne.</p>
<p><b>(GR)</b> Διατηρώνουμε κάθε επιφύλαξη ως προς αλλαγές σε σχέση με κατασκευή, εξοπλισμό, διαρρύθμιση, χρωματισμούς και λάθη παραδρομής.</p>	<p><b>(SK)</b> Zmeny, ktoré sa týkajú konštrukcie, vybavenia, farby, ako aj omyly sú vyhradené. Údaje a zobrazenia sú nezáväzná.</p>
<p><b>(CZ)</b> Změny, týkající se konstrukce, vybavení, barvy, jakož i omyly jsou vyhrazeny. Údaje a vyobrazení jsou nezávazné.</p>	